



MUNRO
SUPPLY

TRUCK & TRAILER

BRASS PIPE, DOT, TUBING, HOSE AND MORE



CALL US

PHONE: 970-242-6810

VISIT US

MUNROSUPPLY.COM

735 S 9TH ST,

GRAND JUNCTION, CO 81501

TRUCK & TRAILER

BRASS PIPE, DOT, TUBING, HOSE AND MORE

PIPE FITTINGS	1
D.O.T. PUSH-IN TUBE FITTINGS	13
COMPOSITE BODY DOT AIRBRAKE FITTINGS	20
D.O.T. AIR BRAKE - NYLON TUBING	25
D.O.T AIR BRAKE - COPPER TUBING	30
D.O.T. AIR BRAKE REUSABLE HOSE/ FITTINGS	32
STEEL GREASE FITTINGS	35
ADAPTERS FOR GREASE FITTINGS	39
SPECIALTY VALVES AND COCKS	40
AIR COILS	48
HOSE SUPPORT	49
GLAD HANDS	52
AIR CYLINDER	56
COILED CABLE AND ELECTRICAL	60
ACCESSORIES	66
NYLON D.O.T AIR BRAKE TUBING	68
FUEL LINE AND AIRBRAKE HOSE	69
WORM GEAR CLAMPS	70
CONSTANT TORQUE HOSE CLAMPS	75
MUFFLER CLAMPS	76
EXHAUST CLAMPS	77
SILICONE HOSE	78

PIPE FITTINGS



Pipe Size	1/16	1/8	1/4	3/8	1/2	3/4	1
Thread Size	1/16-27	1/8-27	1/4-18	3/8-18	1/2-14	3/4-14	1-11 ¹ / ₂
Working Pressure	1200	1200	1200	1200	1200	1000	1000
Thread OD	1/4	3/8	1/2	5/8	3/4	1	1-1/4

Typical Application: Grease, fuels, LP and Natural gas (available on special order), refrigeration, instrumentation and hydraulic systems.

Pressure: Operating pressure up to 1200 PSI.

Vibration: Fair resistance.

Temperature Range:

-65°F to +250°F (-53°C to +121°C).

Used With: Brass, bronze, copper, steel, aluminum and iron pipe.

Tolerance : +/- .02 on all dimensions. Dimension Data can change without notice. Please call us when dimensions are critical.

Conformance: Meets specifications and standards of ASA, ASME and SAE

- Not lead free

- **"L" at the end of a Part# means Light Pattern**

- these fittings are completely interchangeable with full pattern fittings, but have been modified in some way. This modification is usually in the length of the pipe threads. Used in plumbing and light industrial applications.

• Assembly Instructions

1 - Tighten approximately 2-1/2 turns past hand tight.

2 - Fittings with Everseal tighten two turns past hand tight. Brittle materials require special cautions.

- see page 547-550 for stainless steel

- see page 313 for steel fittings

- see page 295-297 for plastic pipe fittings.

- Lead Free Fittings

see pages 157-160

- For Bronze & Larger Sizes

see pages 248-268

- For BSPT/ BSPP

see online

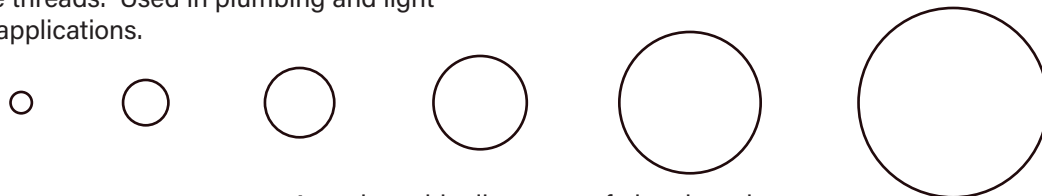

Actual outside diameters of pipe threads



Actual Male Thread Profiles

WARNING: This product can expose you to chemicals, including lead, which are known to the State of California to cause cancer and birth defects or other reproductive harm. For more information, visit www.P65Warnings.ca.gov

PIPE

TRUCK AND TRAILER

90° FEMALE ELBOW

SAE# 130238

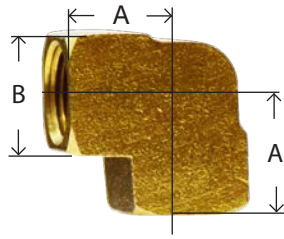

100

PART #	THREAD SIZE NPTF	A	B	APPROX. WT. LBS.	
28001	1/8"	0.55	0.56	0.09	----
28002	1/4"	0.78	0.68	0.13	----
28003	3/8"	0.84	0.81	0.16	----
28004	1/2"	1.09	1.00	0.34	----
28005	3/4"	1.16	1.25	0.60	----
28015B	3/8" x 1/4"	0.84	0.81	0.18	----
28053B	1/2" x 1/4"	1.09	1.00	0.37	----
28016B	1/2" x 3/8"	1.09	1.00	0.36	----

100 2200P 3500 302 200

90° FORGED FEMALE ELBOW

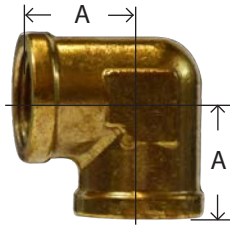

100F

PART #	THREAD SIZE NPTF	A	BODY WIDTH	APPROX. WT. LBS.	
28009	1/8"	0.57	0.50	0.04	----
28010	1/4"	0.70	0.68	0.10	----
28011	3/8"	0.81	0.81	0.12	----
28012	1/2"	1.00	1.00	0.23	----
28013	3/4"	1.13	1.25	0.42	----
28014	1/4" x 1/8"	0.72	0.65	0.12	----
28015	3/8" x 1/4"	0.81	0.81	0.15	----
28016	1/2" x 3/8"	1.00	1.00	0.28	----
28017	1"	1.42	1.50	0.75	----

1200P E7 100AF 100B

45° FEMALE ELBOW

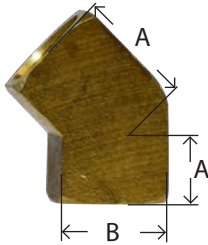

10045

PART #	THREAD SIZE NPTF	A	B	APPROX. WT. LBS.	
28018	1/8"	0.45	0.56	0.06	----
28019	1/4"	0.66	0.68	0.12	----
28020	3/8"	0.69	0.81	0.16	----
28021B	1/2"	0.94	1.00	0.25	----

129 2201P 205 23355 45EZ 105 100-45A

UNION TEE

SAE# 130438

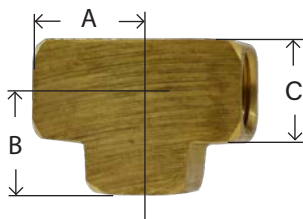

101

PART #	THREAD SIZE NPTF	A	B	C	APPROX. WT. LBS.	
28022	1/16"	0.55	0.55	0.58	0.11	----
28024	1/8"	0.55	0.55	0.56	0.08	----
28025	1/4"	0.78	0.78	0.68	0.17	----
28026	3/8"	0.84	0.84	0.81	0.22	----
28027	1/2"	1.09	1.09	1.00	0.43	----
28028	3/4"	1.16	1.16	1.25	0.64	----

311 101A 322 2203P 3700 203

UNION FORGED TEE

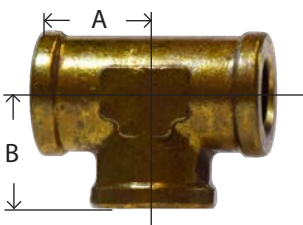

101F

PART #	THREAD SIZE NPTF	A & B	BODY WIDTH	APPROX. WT. LBS.	
28032	1/8"	0.56	0.50	0.06	----
28033	1/4"	0.71	0.68	0.13	----
28034	3/8"	0.81	0.81	0.16	----
28035	1/2"	1.00	1.00	0.27	----
28036	3/4"	1.16	1.25	0.53	----
28023	1"	1.42	1.50	.924	----

1203P LT7 101AF 101B

WARNING: This product can expose you to chemicals, including lead, which are known to the State of California to cause cancer and birth defects or other reproductive harm. For more information, visit www.P65Warnings.ca.gov

PIPE

TRUCK AND TRAILER

REDUCING FORGED TEES

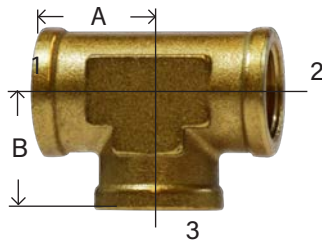

101FR

PART #	1 NPT	2 NPT	3 NPT	A & B	BODY WIDTH	APPROX. WT. LBS.	
28029	1/8"	1/8"	1/4"	0.72	0.69	0.16	----
28030	1/4"	1/4"	1/8"	0.72	0.69	0.14	----
28031	1/4"	1/4"	3/8"	0.81	0.81	0.21	----
28038	3/8"	1/4"	3/8"	0.81	0.81	0.18	----
28039	3/8"	3/8"	1/4"	0.81	0.81	0.18	----
28046	1/2"	1/2"	3/8"	1.00	1.00	0.30	----
28047	3/4"	1/2"	3/4"	1.20	1.25	0.59	----
28048	3/4"	3/4"	1/2"	1.16	1.25	0.59	----

CROSS

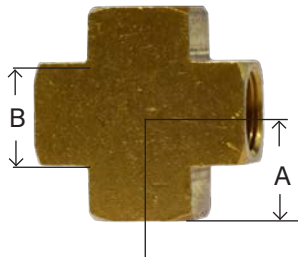

102

PART #	THREAD SIZE NPTF	A	B	APPROX. WT. LBS.	
28041	1/8"	0.55	0.56	0.10	----
28042	1/4"	0.78	0.68	0.21	----
28043	3/8"	0.84	0.81	0.25	----
28044	1/2"	1.09	1.00	0.51	----
28045	3/4"	1.16	1.25	0.75	----

2205P 3950 228 102A 102BE

FORGED CROSS

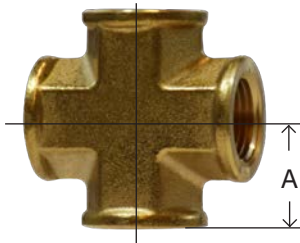

102F

PART #	THREAD SIZE NPTF	A	BODY WIDTH	APPROX. WT. LBS.	
28049	1/8"	0.56	0.50	0.06	----
28050	1/4"	0.72	0.69	0.15	----
28051	3/8"	0.81	0.81	0.18	----
28052	1/2"	1.00	1.00	0.34	----

C7 105 102AF 102B

COUPLING

SAE# 130138

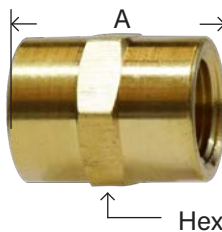

103

PART #	THREAD SIZE NPTF	A	HEX	APPROX. WT. LBS.	
28057	1/16"	0.75	0.44	0.02	
28058L	1/8"	0.75	0.50	0.02	----
28058	1/8"	0.75	0.56	0.03	----
28059L	1/4"	0.88	0.63	0.03	----
28059	1/4"	1.12	0.75	0.09	----
28060L	3/8"	1.00	0.81	0.06	----
28060	3/8"	1.12	0.87	0.10	----
28061L	1/2"	1.19	0.93	0.09	----
28061	1/2"	1.50	1.06	0.19	----
28062L	3/4"	1.19	1.25	0.18	----
28062	3/4"	1.53	1.25	0.24	----
28063	1"	1.89	1.50	.357	----

207P 371 3300 103AH 103B

DIMENSION DATA CAN CHANGE WITHOUT NOTICE. PLEASE SEE WEBSITE WHEN DIMENSIONS ARE CRITICAL.

PIPE

TRUCK AND TRAILER

REDUCING COUPLING

SAE# 130138

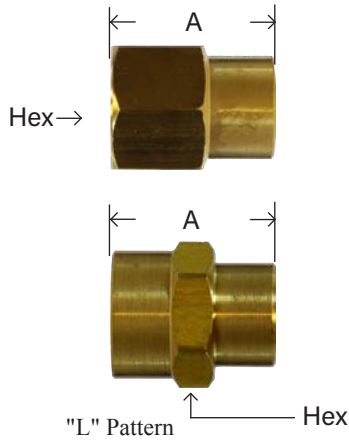

119

PART #	THREAD SIZE NPTF	A	HEX	APPROX. WT. LBS.	
28181L	1/4" x 1/8"	0.94	0.62	0.04	----
28181	1/4" x 1/8"	0.97	0.75	0.08	----
28182	3/8" x 1/8"	0.94	0.87	0.10	----
28183L	3/8" x 1/4"	1.00	0.81	0.06	----
28183	3/8" x 1/4"	1.16	0.87	0.12	----
28180*	1/2" x 1/8"	1.19	0.93	0.15	----
28184L	1/2" x 1/4"	1.11	1.00	0.10	----
28184	1/2" x 1/4"	1.28	1.06	0.20	----
28185L	1/2" x 3/8"	1.19	0.93	0.10	----
28185	1/2" x 3/8"	1.38	1.06	0.20	----
28187	3/4" x 1/4"	1.19	1.19	0.17	----
28188*	3/4" x 3/8"	1.32	1.37	0.20	----
28189*	3/4" x 1/2"	1.19	1.18	0.14	----
28178	1" x 1/2"	1.50	1.56	0.41	----
28179	1" x 3/4"	1.56	1.56	0.39	----

*Not to SAE specs

377 3300 208P 108 119B 119AH

UNION

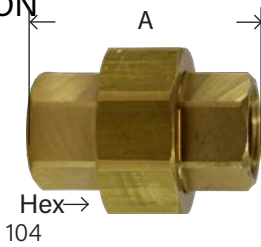

PART #	THREAD SIZE NPTF	A	HEX	APPROX. WT. LBS.	
28067	1/8"	1.25	0.94	0.13	----
28068	1/4"	1.31	1.06	0.18	----
28069	3/8"	1.75	1.25	0.33	----
28070	1/2"	1.79	1.56	0.50	----
28071	3/4"	1.96	1.68	0.47	----

3250 212P 104A 104B

CAP

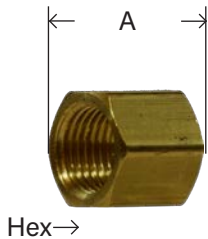

PART #	THREAD SIZE NPTF	A	HEX	APPROX. WT. LBS.	
28075	1/8"	0.47	0.56	0.03	----
28076	1/4"	0.60	0.68	0.04	----
28077	3/8"	0.69	0.81	0.06	----
28078	1/2"	0.78	0.93	0.08	----
28079	3/4"	0.94	1.25	0.16	----
28080	1"	1.13	1.50	0.23	----

3129 213P 23129 108A 108B

• See website for larger sizes

90° STREET ELBOW

SAE# 130239

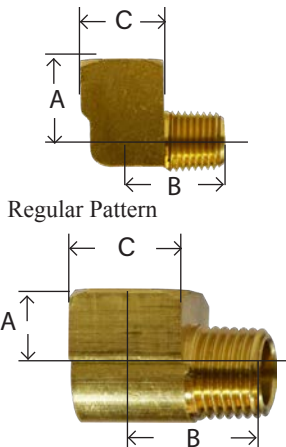

PART #	THREAD SIZE NPTF	A	B	C	APPROX. WT. LBS.	
28161	1/16"	0.69	0.60	0.47	0.04	----
28156	1/8"	0.48	0.66	0.56	0.05	----
28156S	1/8" short	0.34	0.57	0.50	0.03	----
28157	1/4"	0.72	0.91	0.735	0.09	----
28157S	1/4" short	0.45	0.78	0.68	0.07	----
28158	3/8"	0.78	0.97	0.81	0.16	----
28159	1/2"	1.03	1.25	1.00	0.33	----
28160	3/4"	1.12	1.38	1.25	0.52	----

2202P 304 115 202 3400 116A

WARNING: This product can expose you to chemicals, including lead, which are known to the State of California to cause cancer and birth defects or other reproductive harm. For more information, visit www.P65Warnings.ca.gov

PIPE

TRUCK AND TRAILER

FORGED 90° STREET ELBOW

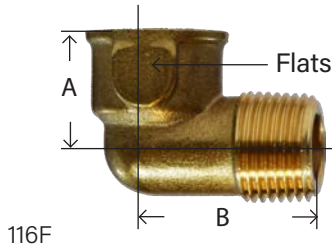

PART #	THREAD SIZE NPTF	A	B	WRENCH FLATS	APPROX. WT. LBS.	
28165	1/8"	0.61	0.85	0.62	0.06	----
28166	1/4"	0.50	0.86	0.72	0.08	----
28167	3/8"	0.70	1.00	0.88	0.10	----
28168	1/2"	0.96	1.43	1.00	0.20	----
28169	3/4"	0.90	1.40	1.25	0.25	----

5E8 1202P 116AF 116B

FORGED REDUCING 90° STREET ELBOW

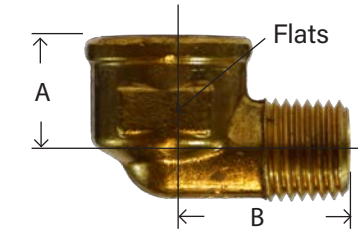

128

*Barstock

PART #	THREAD SIZE NPTF FXM	A	B	WRENCH FLATS	APPROX. WT. LBS.	
28259*	1/8" x 1/16"					----
28260	1/8" x 1/4"	0.50	0.87	0.71	0.08	----
28261B*	1/4" x 1/8"	0.53	0.72	0.69	0.07	----
28261	1/4" x 1/8"	0.50	0.81	0.72	0.06	----
28262	1/4" x 3/8"	0.93	1.06	0.59	0.12	----
28263	3/8" x 1/4"	0.58	0.94	0.81	0.07	----
28264	3/8" x 1/2"	0.97	1.36	1.00	0.28	----
28265	1/2" x 3/8"	0.96	1.37	1.00	0.22	----
28265B*	1/2" x 3/8"	1.03	1.11	1.00	0.24	----

PIPE SWIVEL 90° STREET ELBOW

▪ Burst Pressure 1,200 PSI ▪ Working Pressure 300 PSI

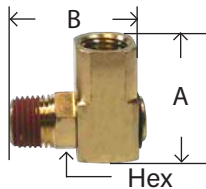

PART #	MIP XFIP THREAD SIZE NPTF	A	B	HEX	APPROX. WT. LBS.	LIST PRICE
28430	1/4"	1.18	1.25	.625	0.22	----

HEX BUSHING

SAE# 130140

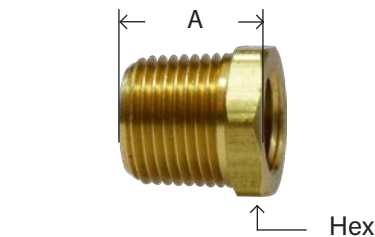

110

PART #	THREAD SIZE NPTF MXF	A	HEX	APPROX. WT. LBS.	
28101	1/8" x 1/16"				
28102L	1/4" x 1/8"	0.62	0.56	0.02	----
28102	1/4" x 1/8"	0.75	0.56	0.04	----
28103	3/8" x 1/8"	0.75	0.68	0.05	----
28104L	3/8" x 1/4"	0.69	0.68	0.03	----
28104	3/8" x 1/4"	0.75	0.75	0.05	----
28105L	1/2" x 1/8"	0.81	0.81	0.08	----
28105	1/2" x 1/8"	1.00	0.87	0.10	----
28106L	1/2" x 1/4"	0.81	0.81	0.08	----
28106	1/2" x 1/4"	1.00	0.87	0.11	----
28107L	1/2" x 3/8"	0.81	0.81	0.05	----
28107	1/2" x 3/8"	1.00	0.87	0.10	----
28108	3/4" x 1/8"	0.94	1.06	0.20	----
28109L	3/4" x 1/4"	0.94	1.06	0.18	----
28110L	3/4" x 3/8"	0.94	1.06	0.15	----
28111L	3/4" x 1/2"	0.94	1.06	0.11	----
28111	3/4" x 1/2"	1.00	1.12	0.14	----
28091	1" x 1/8"	1.15	1.37	0.29	----
28112	1" x 1/4"	1.15	1.37	0.32	----
28113	1" x 3/8"	1.12	1.37	0.30	----
28114	1" x 1/2"	1.31	1.44	0.29	----
28115	1" x 3/4"	1.31	1.37	0.20	----

373 3220 209P 110A 110B

PIPE

TRUCK AND TRAILER

FACE BUSHING



110F

PART #	THREAD SIZE NPTF MXF	A	APPROX. WT. LBS.	
28121	1/4" x 1/8"	0.45	0.01	----
28122	3/8" x 1/8"	0.50	0.03	----
28116	3/8" x 1/4"	0.50	0.02	----
28090	1/2" x 1/8"	0.56	0.06	----
28128	1/2" x 1/4"	0.56	0.05	----
28117	1/2" x 3/8"	0.56	0.03	----
28129	3/4" x 1/4"	0.62	0.11	----
28130	3/4" x 3/8"	0.62	0.08	----
28118	3/4" x 1/2"	0.64	0.03	----
28120	1" x 1/2"	0.75	0.11	----
28119	1" x 3/4"	0.77	0.10	----

SQUARE HEAD PLUG

1/8 - 1/2 Solid

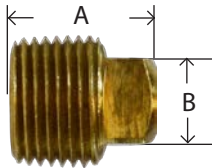

109

PART #	THREAD SIZE NPTF	A	B	APPROX. WT. LBS.	
28084	1/8"	0.58	0.27	0.02	----
28085	1/4"	0.80	0.37	0.03	----
28086	3/8"	0.80	0.43	0.06	----
28087	1/2"	1.07	0.55	0.13	----
28088**	3/4"	1.09	0.61	0.20	----
28089**	1"	1.24	0.81	0.35	----

** Cored

3151 211P 109A 109B

• See website for larger sizes

COUNTERSUNK HEX PLUG

3/4" taper thread

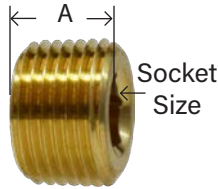

109AL

PART #	THREAD SIZE NPTF	A	SOCKET SIZE	APPROX. WT. LBS.	
28092	1/16"	0.30	0.12	0.01	----
28093	1/8"	0.30	0.18	0.01	----
28094	1/4"	0.45	0.26	0.02	----
28095	3/8"	0.45	0.31	0.03	----
28096	1/2"	0.61	0.39	0.05	----

3153 219P 109CS 118

SLOTTED-HEAD PLUG



117

PART #	THREAD SIZE NPTF	A	APPROX. WT. LBS.	
28174	1/8"	0.31	0.01	----
28175	1/4"	0.42	0.02	----
28176	3/8"	0.45	0.05	----

220P 3150 117A 117B

CORED HEX PLUGS

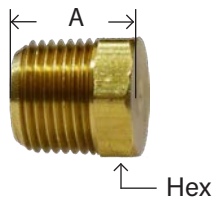

121

PART #	THREAD SIZE NPTF	A	HEX	APPROX. WT. LBS.	
28200	1/16"	0.48	0.38	0.01	----
28201	1/8"	0.55	0.43	0.01	----
28202	1/4"	0.62	0.56	0.02	----
28203	3/8"	0.72	0.68	0.06	----
28204	1/2"	0.81	0.87	0.09	----
28205	3/4"	0.94	1.06	0.16	----

WARNING: This product can expose you to chemicals, including lead, which are known to the State of California to cause cancer and birth defects or other reproductive harm. For more information, visit www.P65Warnings.ca.gov

PIPE

TRUCK AND TRAILER

SOLID HEX HEAD PLUGS

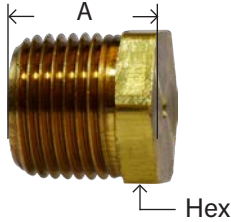

121S

PART #	THREAD SIZE NPTF	A	HEX	APPROX. WT. LBS.	
28201S	1/8"	0.55	0.43	0.02	----
28202S	1/4"	0.75	0.56	0.05	----
28203S	3/8"	0.66	0.68	0.07	----
28204S	1/2"	0.81	0.87	0.12	----
28205S	3/4"	0.92	1.06	0.24	----

121AS

LOCKNUT

- Jam Nuts
- Straight pipe thread

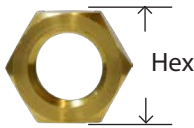

111

PART #	THREAD SIZE NPSL	HEX	THICKNESS	APPROX. WT. LBS.	
28123	1/8"	0.68	0.19	0.02	----
28124	1/4"	0.87	0.25	0.04	----
28125	3/8"	1.00	0.31	0.04	----
28126	1/2"	1.125	0.25	0.04	----
28127	3/4"	1.38	0.38	0.09	----

210P 21102 111A 111B

CLOSE NIPPLE

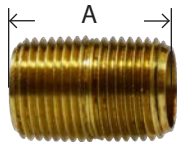

112

PART #	THREAD SIZE NPTF	A	APPROX. WT. LBS.	
28131	1/8"	0.75	0.01	----
28132	1/4"	0.88	0.02	----
28133	3/8"	1.00	0.05	----
28134	1/2"	1.12	0.06	----
28135	3/4"	1.31	0.11	----

165 215PN 3326 112A 112B

LONG NIPPLE

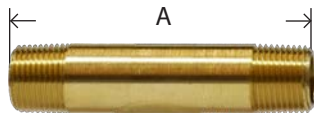

113

PART #	THREAD SIZE NPTF	A LENGTH	APPROX. WT. LBS.	
28140	1/8"	1.50	0.03	----
28141	1/8"	2.00	0.04	----
28142	1/8"	2.50	0.06	----
28143	1/8"	3.00	0.06	----
28475	1/8"	3.50	0.07	----
28144	1/4"	1.50	0.03	----
28145	1/4"	2.00	0.05	----
28146	1/4"	2.50	0.08	----
28147	1/4"	3.00	0.10	----
28481	1/4"	3.50	0.12	----
28148	3/8"	1.50	0.06	----
28149	3/8"	2.00	0.10	----
28150	3/8"	2.50	0.10	----
28151	3/8"	3.00	0.13	----
28487	3/8"	3.50	0.17	----
28152	1/2"	1.50	0.08	----
28153	1/2"	2.00	0.12	----
28154	1/2"	2.50	0.16	----
28155	1/2"	3.00	0.20	----
28493	1/2"	3.50	0.24	----
28136	3/4"	1.50	0.12	----
28497	3/4"	2.00	0.18	----
28498	3/4"	2.50	0.23	----
28499	3/4"	3.00	0.28	----

- NOTE: For longer lengths and larger diameters, see our red brass nipples section.



113B 113A 166 3327, 3328, 3329, 3330 3331 215PNL

PIPE

TRUCK AND TRAILER

HEX NIPPLE

SAE# 130137

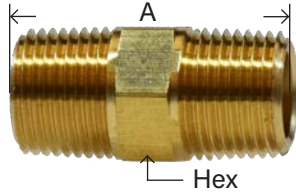

122

PART #	THREAD SIZE NPTF	A	HEX	APPROX. WT. LBS.	
28210	1/16"	0.97	0.38	0.02	----
28211L	1/8"	0.91	0.43	0.02	----
28211	1/8"	0.97	0.43	0.03	----
28212L	1/4"	1.12	0.56	0.04	----
28212	1/4"	1.38	0.56	0.06	----
28213L	3/8"	1.25	0.68	0.07	----
28213	3/8"	1.41	0.68	0.07	----
28214L	1/2"	1.50	0.87	0.11	----
28214	1/2"	1.81	0.87	0.17	----
28215L	3/4"	1.55	1.07	0.17	----
28215	3/4"	1.96	1.13	0.23	----
28216L	1"	1.75	1.39	0.22	----

216P 3325 379 122AH 122B

REDUCING HEX NIPPLE

SAE# 130137

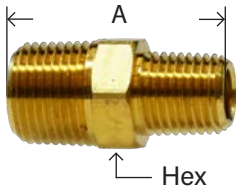

123

PART #	THREAD SIZE NPTF	A	HEX	APPROX. WT. LBS.	
28218	1/8" x 1/16"	1.00	0.56	0.05	----
28220L	1/4" x 1/8"	1.00	0.56	0.04	----
28220	1/4" x 1/8"	1.19	0.56	0.04	----
28221L	3/8" x 1/8"	1.11	0.68	0.06	----
28221	3/8" x 1/8"	1.22	0.68	0.07	----
28222L	3/8" x 1/4"	1.19	0.68	0.06	----
28222	3/8" x 1/4"	1.41	0.68	0.07	----
28223L	1/2" x 1/4"	1.34	0.87	0.09	----
28223	1/2" x 1/4"	1.62	0.87	0.12	----
28224L	1/2" x 3/8"	1.41	0.87	0.11	----
28224	1/2" x 3/8"	1.62	0.87	0.12	----
28225L	3/4" x 1/2"	1.81	1.06	0.19	----
28225	3/4" x 1/2"	1.50	1.06	0.15	----
28227	1" x 3/4"	2.31	1.38	0.38	----

216P 3325 379 122AH 122B

45° STREET ELBOW

SAE# 130339

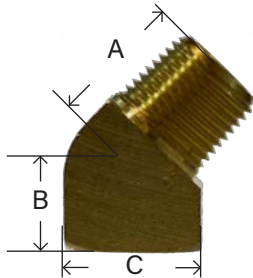

124

PART #	THREAD SIZE NPTF	B	A	C	APPROX. WT. LBS.	
28230	1/8"	0.38	0.50	0.56	0.03	----
28231	1/4"	0.56	0.72	0.68	0.09	----
28232	3/8"	0.56	0.78	0.81	0.12	----
28233	1/2"	0.75	1.00	1.00	0.20	----
28234	3/4"	0.75	1.06	1.25	0.34	----

306 3350 2214P 224

45° FORGED STREET ELBOW

124F

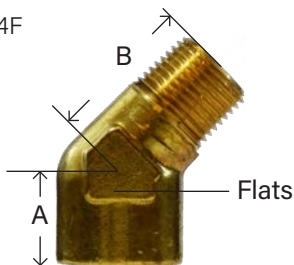

PART #	THREAD SIZE NPTF	A	B	WRENCH FLATS	APPROX. WT. LBS.	
28238	1/8"	0.63	0.81	0.56	0.05	----
28239	1/4"	0.63	1.06	0.81	0.11	----
28240	3/8"	0.72	1.06	0.93	0.17	----

45E8 124B

PIPE

TRUCK AND TRAILER

STREET TEE/ SERVICE TEE/ MALE RUN TEE

SAE# 130424

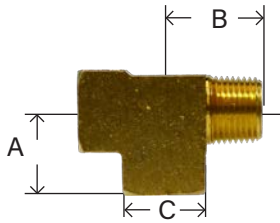

127

PART #	THREAD SIZE NPTF	A	B	C	APPROX. WT. LBS.	
28245	1/8"	0.55	0.66	0.56	0.08	----
28246	1/4"	0.78	0.91	0.68	0.17	----
28247	3/8"	0.84	0.97	0.81	0.22	----
28248	1/2"	1.09	1.25	1.00	0.40	----
28249	3/4"	1.16	1.39	1.25	0.60	----

FORGED STREET TEE

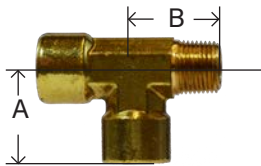

127F

PART #	THREAD SIZE NPTF	A	B	BODY WIDTH	APPROX. WT. LBS.	
28253	1/8"	0.56	0.75	0.50	0.05	----
28254	1/4"	1.03	1.00	0.46	0.13	----
28255	3/8"	1.19	1.09	0.68	0.24	----
28256	1/2"	1.52	1.40	0.88	0.45	----

107 T8 127B

EXTENDER ADAPTER

SAE# 130139

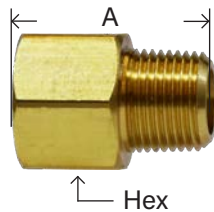

120

PART #	THREAD SIZE NPTF FXM	A	HEX	APPROX. WT. LBS.	
28190L	1/8" x 1/8"	0.83	0.50	0.03	----
28190	1/8" x 1/8"	0.88	0.56	0.04	----
28191L	1/4" x 1/8"	0.94	0.62	0.04	----
28191	1/4" x 1/8"	1.06	0.75	0.07	----
28192L	1/4" x 1/4"	1.00	0.62	0.04	----
28192	1/4" x 1/4"	1.25	0.75	0.07	----
28198	3/8" x 1/8"	1.00	0.81	0.06	----
28193L	3/8" x 1/4"	1.12	0.81	0.08	----
28193	3/8" x 1/4"	1.25	0.87	0.09	----
28194L	3/8" x 3/8"	1.24	0.81	0.10	----
28194	3/8" x 3/8"	1.25	0.87	0.11	----
28197	1/2" x 1/8"	1.09	0.94	0.07	----
28199	1/2" x 1/4"	1.46	1.06	0.08	----
28195L	1/2" x 3/8"	1.19	0.93	0.09	----
28195	1/2" x 3/8"	1.47	1.06	0.18	----
28196L	1/2" x 1/2"	1.25	0.94	0.10	----
28196	1/2" x 1/2"	1.66	1.06	0.12	----
28207	3/4" x 3/8"	1.59	1.25	0.26	----
28208	3/4" x 1/2"	1.69	1.37	0.14	----
28208L	3/4" x 1/2"	1.22	1.25	0.13	----
28209	3/4" x 3/4"	1.69	1.37	0.34	----

375 222P 3200 R1 120AH 120B

PIPE SWIVEL ADAPTER

*300 PSI all sizes

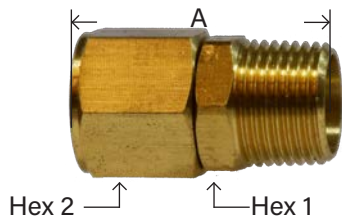

MALE NPT X FEMALE NPT

- 360° Turning
- Swivels



PART #	THREAD SIZE NPTF FXM	A	HEX 1	HEX 2	APPROX. WT. LBS.	
28424	1/8"	1.10	0.43	0.50	0.05	----
28425	1/4"	1.34	0.56	0.62	0.06	----
28426	3/8"	1.36	0.68	0.75	0.08	----
28427	1/2"	1.87	0.87	0.95	0.10	----

PART #	SIZE	
320061	1/4	----

344R 3183

PIPE

TRUCK AND TRAILER

FORGED 90° MALE ELBOW

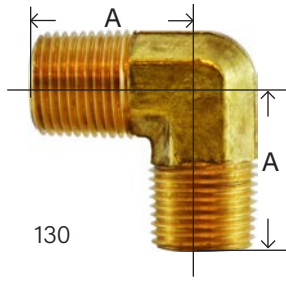

PART #	THREAD SIZE NPTF	A	BODY WIDTH	APPROX. WT. LBS.	
28266	1/8"	0.79	0.38	0.04	----
28267	1/4"	0.87	0.45	0.06	----
28268	3/8"	1.06	0.59	0.12	----
28269	1/2"	1.38	0.78	0.21	----

LE5 3455 116AMF

BARSTOCK 90° MALE ELBOW

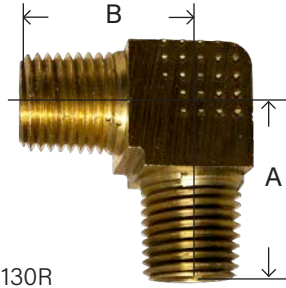

PART #	THREAD SIZE NPTF	A	BODY WIDTH	APPROX. WT. LBS.	
28266B	1/8"	0.69	0.56	0.08	----
28267B	1/4"	0.95	0.59	0.09	----
28268B	3/8"	1.01	0.71	0.15	----
28269B	1/2"	1.40	1.00	0.38	----
28270B	3/4"	1.50	1.25	0.55	----
28276B	1/2" x 3/8"	1.12	1.00	0.35	----

FORGED 90° MALE REDUCING ELBOW



PART #	THREAD SIZE NPTF	A	B	BODY WIDTH	APPROX. WT. LBS.	
28274	1/4" x 1/8"	0.88	0.78	0.47	0.06	----
28275	3/8" x 1/4"	0.90	0.90	0.46	0.06	----
28276	1/2" x 3/8"	1.12	1.00	0.59	0.12	----

MALE BRANCH TEE

SAE# 130425

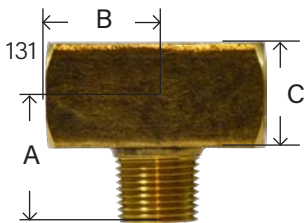

PART #	THREAD SIZE NPTF	A	B	C	APPROX. WT. LBS.	
28281	1/8"	0.66	0.55	0.56	0.08	----
28282	1/4"	0.91	0.78	0.68	0.15	----
28283	3/8"	0.97	0.84	0.81	0.22	----
28284	1/2"	1.25	1.09	1.00	0.40	----
28285	3/4"	1.38	1.16	1.25	0.62	----

T9 X106 23601 3600 2224P 226 329 128

FORGED MALE BRANCH TEE

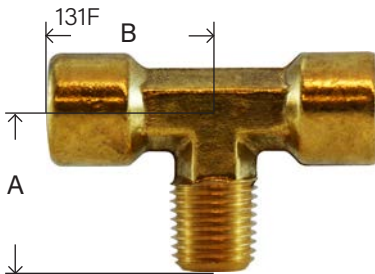

PART #	THREAD SIZE NPTF	A	B	BODY WIDTH	APPROX. WT. LBS.	
28281F	1/8"	0.75	0.56	0.50	0.06	----
28282F	1/4"	1.00	1.03	0.46	0.12	----

T9

WARNING: This product can expose you to chemicals, including lead, which are known to the State of California to cause cancer and birth defects or other reproductive harm. For more information, visit www.P65Warnings.ca.gov

PIPE

TRUCK AND TRAILER

FORGED ALL MALE TEE

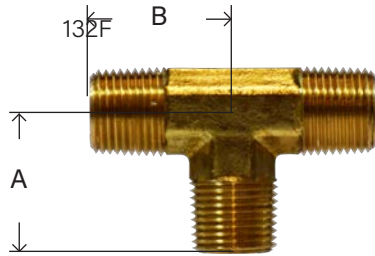

PART #	THREAD SIZE NPTF	A	B	BODY WIDTH	APPROX. WT. LBS.	
28290	1/8"	0.75	0.75	0.43	0.06	----
28291	1/4"	0.86	0.86	0.43	0.08	----
28292	3/8"	1.09	1.09	0.60	0.16	----
28293	1/2"	1.22	1.22	0.68	0.22	----
28294	3/4"	1.43	1.43	0.87	0.38	----

T12 M101

LONG STREET ELLS

D.O.T. Approved

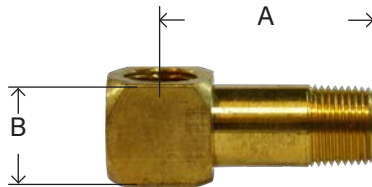

PART #	THREAD SIZE NPTF	A	B	APPROX. WT. LBS.	
28440	1/8"	1-3/16"	0.50	0.06	----
28441	1/8"	1-7/16"	0.50	0.06	----
28442	1/8"	1-11/16"	0.50	0.06	----
28443	1/8"	1-7/8"	0.50	0.16	----
28328	1/4"	1-3/16"	0.75	0.12	----
28329	1/4"	1-7/16"	0.75	0.14	----
28330	1/4"	1-11/16"	0.75	0.15	----
28331	1/4"	1-7/8"	0.62	0.09	----
28332	1/4"	2-1/4"	0.75	0.17	----
28333	3/8"	1-3/4"	0.87	0.22	----

LONG EXTENSION ADAPTERS

D.O.T. Approved

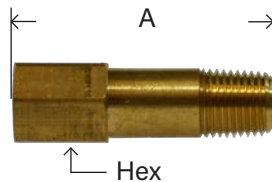

PART #	THREAD SIZE NPTF	A	HEX	APPROX. WT. LBS.	
28335	1/8"	1-1/4"	0.50	0.04	----
28336	1/8"	1-3/4"	0.50	0.05	----
28337	1/8"	3"	0.50	0.09	----
28338	1/4"	1-9/16"	0.62	0.07	----
28339	1/4"	1-13/16"	0.62	0.08	----
28340	1/4"	2-1/16"	0.62	0.10	----

PIPE WYE FIP X MIP

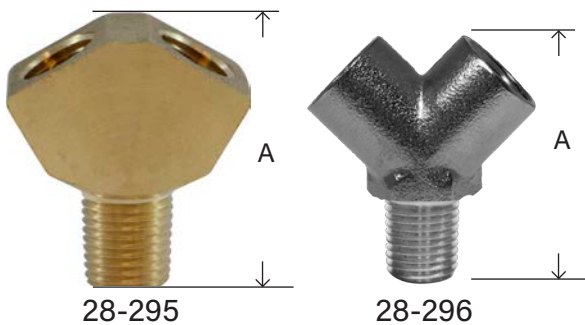

PART #	THREAD SIZE NPT	A	APPROX. WT. LBS.	
28295	1/4"	1.56	.15	----
28296	1/4 N/P	1.4	.12	----

PIPE WYE FIP X FIP - NICKEL PLATED



PART #	THREAD SIZE NPT	A	APPROX. WT. LBS.	
28298	1/4	1.4	.12	----

SEE OUR WEBSITE FOR BSPT, BSPP & BSP FITTINGS

BULKHEAD FITTINGS

TRUCK AND TRAILER

BULKHEAD / ANCHOR / FRAME COUPLINGS

FEMALE PIPE X
FEMALE PIPE

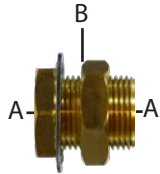

Part #	Terminal Bolts/ Frame		Hole Size	Length (in.)	
	A	B			
28299	1/8-27 NPTF	5/8-18 UNS	5/8	0.96	----
28300	1/8-27 NPTF	5/8-18 UNS	5/8	1-1/2	----
28301	1/4-18 NPTF	3/4-16 UNS	3/4	15/16	----
28302	1/4-18 NPTF	3/4-16 UNS	3/4	1-1/2	----
28315*	1/4-18 NPTF	3/4-16 UNS	3/4	1-1/2	----
28303	3/8-18 NPTF	1-14 UNS	1	1-5/16	----
28304	1/2-14 NPTF	1-1/8-14 UNS	1-1/8	1-1/2	----
28311	3/4-14 NPTF	1-5/16-12	1-5/16	1-1/2	----
28316**	1-11/1/2	1-5/8-14	1-5/8	1.68	----

* Same as 28-302 except with a larger mounting nut. **Without washer

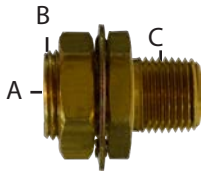

FEMALE PIPE X MALE PIPE

	A	B	C		
28317	1/4-18 NPTF	1-14 UNS	1/2-14 NPTF	2-1/8	----
28318	3/8-18 NPTF	1-14 UNS	1/2-14 NPTF	1-11/16	----
28319	3/8-18 NPTF	1-14 UNS	1/2-14 NPTF	1-29/32	----



FEMALE PIPE X MALE PIPE

28313	1/4-18 NPTF	1-14 UNS	1/2-14 NPTF	2-7/8	----
-------	-------------	----------	-------------	-------	------

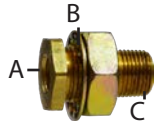

FEMALE PIPE X MALE PIPE

28346	3/8-18 NPTF	1-14 UNS	1/2-14 NPTF	1-7/8	----
28347	1/2-14 NPTF	1-14 UNS	1/2-14 NPTF	2-3/8	----

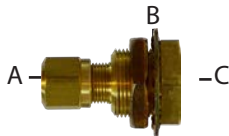

TUBE X FEMALE PIPE

28321	1/2-O.D. Tube	7/8-20 UNCF	3/8-18 NPTF	1-5/16	----
28322	3/8-O.D. Tube	7/8-20 UNCF	3/8-18 NPTF	1-3/8	----

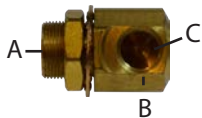

FEMALE PIPE X CLAMPING STUD ELBOW

28348	3/8-18 NPTF	7/8-20 UNEF	3/8-18 NPTF	2-5/16	----
-------	-------------	-------------	-------------	--------	------



BRASS MARINE BULKHEAD

46540	5/16 Hose ID	----	----	2.37	----
46541	3/8 Hose ID	----	----	2.37	----

CROSSOVER NUMBERS

28-300	207x2	129A-A	50004	55207						1495B-A	ACBH207-2	207ACBH-2				
28-301	207X4	129AS-B		55611		S611	114-44	1345	382-44S	392C-94	ACBHS207-4					
28-302	207X4	129A-B	50005	55661			114B-44	1344	382-44L		035081	ACBH207-4	207ACBH-4		11306	90648
28-303	207X6	129A-C	50006	55607		S661/S607	114-66	1346	382-66		035087	ACBH207-6	207ACBH-6		11307	17709
28-304	207X8	129A-D	50007	55807		S807	114-88	1351				ACBH207-8	207ACBH-8			
28-317				55615		S615	117-84									
28-318				55620		S620			381-86S					11304		
28-319			50001				115-86			035079	1496-DC					
28-313			50010	55600		S664	115-88	1342	380-84	5730	035021			11300	55X6	
28-346			50013	55613		S613										
28-347			50012	55629		S629					035039					
28-321							391-86/1347									
28-322							391-66									
28-348				55616												

WARNING: This product can expose you to chemicals, including lead, which are known to the State of California to cause cancer and birth defects or other reproductive harm. For more information, visit www.P65Warnings.ca.gov

D.O.T. PUSH-IN TUBE FITTINGS



Meets D.O.T. FMVSS 571.106 SAE J1131 Air Brake System Require-

Benefits for Cost Savings & Engineering Project

- **Fast assembly:** No tools required. Simply push tubing in. Saves up to 75% of assembly time compared to standard air compression fittings. No loose parts to handle.
- **Fast disconnect:** Hold the collet collar with two fingers and pull out tube. No tools required.
- **Reusable:** Can be connected and disconnected several times.
- **Reliable sealing:** Using recommended tubing, full sealing is guaranteed.
- **Versatility:** Buna N O'ring standard. Viton and others available per request. Secure tube retention. Pulling on tubing only serves to tighten the connection.
- **Pre-Applied Teflon®** based pipe sealant on all male pipe threads, saving customer additional labor.
- **Full Flow Design,** provides more flow area than con-

DOT Fittings are constructed with an all brass captive eyelet which allows for maximum flow. The brass captive eyelet with extended length is floating and has a machined top end radius for easy installation of tubing. All male threads have a pre-applied Teflon® based pipe sealant to provide for easy assembly and leak proof seal.

Materials:

Brass

"O" Ring: Buna - Nitrile (90 Durometer)
EP (Ethylene Propylene)

Working Pressures & Temperature Ranges

Vacuum to 150 PSI

-40°F to 200° F (-40°C to +93°C)

Dimension data can change without notice. Please see our website when dimensions are critical.

D.O.T. PUSH-IN

TRUCK AND TRAILER

PLUG

AQ59DOT

PART #	TUBE O.D.	APPROX. WT. LBS.	
595320	5/32"	0.01	----
590400	1/4"	0.02	----
590600	3/8"	0.02	----
590800	1/2"	0.04	----

1829 DQ59DOT 639PMT

UNIONAQ62DOT
DQ62

PART #	TUBE O.D.	APPROX. WT. LBS.	
620532	5/32"	0.06	----
620400	1/4"	0.06	----
620600	3/8"	0.13	----
620604	3/8" x 1/4"	0.15	----
620800	1/2"	0.19	----
621000	5/8"	0.30	----
621200	3/4"	0.44	----

AQ62DOT 62PMT 1862 DQ62DOT

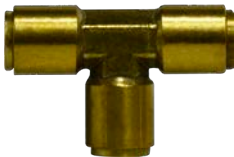
UNION TEEAQ64DOT
DQ64

PART #	TUBE O.D.	APPROX. WT. LBS.	
640400	1/4"	0.09	----
640600	3/8"	0.16	----
640800	1/2"	0.25	----
641000	5/8"	0.32	----
641200	3/4"	0.36	----

AQ64DOT 164 PMT 1864 DQ64DOT

UNION ELBOWAQ65DOT
DQ65

PART #	TUBE O.D.	APPROX. WT. LBS.	
655320	5/32"	0.03	----
650400	1/4"	0.06	----
650600	3/8"	0.12	----
650800	1/2"	0.18	----

WARNING: This product can expose you to chemicals, including lead, which are known to the State of California to cause cancer and birth defects or other reproductive harm. For more information, visit www.P65Warnings.ca.gov



D.O.T. PUSH-IN

TRUCK AND TRAILER

FEMALE CONNECTOR



AQ66DOT
DQ66

PART #	TUBE O.D. X FEMALE NPTF	APPROX. WT. LBS.	
660402	1/4" x 1/8"	0.06	----
660404	1/4" x 1/4"	0.10	----
660602	3/8" x 1/8"	0.11	----
660604	3/8" x 1/4"	0.11	----
660606	3/8" x 3/8"	0.17	----
660804	1/2" x 1/4"	0.14	----
660806	1/2" x 3/8"	0.16	----
660808	1/2" x 1/2"	0.25	----

AQ66DOT 66PMT 1866 DQ66DOT

MALE CONNECTOR

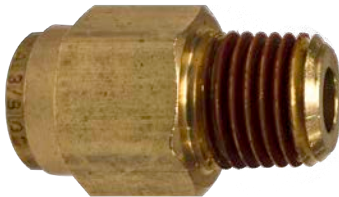

AQ68DOT
DQ68

PART #	TUBE O.D. X MALE NPTF	APPROX. WT. LBS.	
685320	5/32" x 10/32"	0.02	----
685321	5/32" x 1/16"	0.02	----
685322	5/32" x 1/8"	0.02	----
680302	3/16" x 1/8"	0.02	----
680421	1/4" x 1/16"	0.02	----
680402	1/4" x 1/8"	0.03	----
680404	1/4" x 1/4"	0.04	----
680406	1/4" x 3/8"	0.07	----
680602	3/8" x 1/8"	0.06	----
680604	3/8" x 1/4"	0.07	----
680606	3/8" x 3/8"	0.06	----
680608	3/8" x 1/2"	0.13	----
680804	1/2" x 1/4"	0.11	----
680806	1/2" x 3/8"	0.12	----
680808	1/2" x 1/2"	0.14	----
681006	5/8" x 3/8"	0.18	----
681008	5/8" x 1/2"	0.18	----
681208	3/4" x 1/2"	0.20	----
681212	3/4" x 3/4"	0.20	----

AQ68DOT 68PM 1868 DQ68DOT 68PMT

Dimension data can change without notice.
Please see our website when dimensions are critical.

D.O.T. PUSH-IN

TRUCK AND TRAILER

MALE ELBOW

Forged

AQ69DOT
DQ69

PART #	TUBE O.D. X MALE NPTF	APPROX. WT. LBS.	
695302	5/32" x 1/16"	0.03	----
695322	5/32" x 1/8"	0.03	----
690302	3/16" x 1/8"	0.03	----
690402	1/4" x 1/8"	0.08	----
690404	1/4" x 1/4"	0.06	----
690406	1/4" x 3/8"	0.11	----
690602	3/8" x 1/8"	0.08	----
690604	3/8" x 1/4"	0.09	----
690606	3/8" x 3/8"	0.11	----
690608	3/8" x 1/2"	0.20	----
690804	1/2" x 1/4"	0.22	----
690806	1/2" x 3/8"	0.22	----
690808	1/2" x 1/2"	0.24	----
691006	5/8" x 3/8"	0.30	----
691008	5/8" x 1/2"	0.32	----
691208	3/4" x 1/2"	0.32	----
691212	3/4" x 3/4"	0.34	----

AQ69DOT 169PMTNS 1869 DQ69DOT

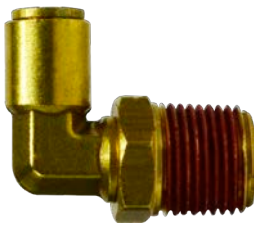
MALE SWIVEL ELBOW

Forged

AQ62DOTS
DQ69S

PART #	TUBE O.D. X MALE NPTF	APPROX. WT. LBS.	
695322S	5/32" x 1/8"	0.07	----
690402S	1/4" x 1/8"	0.06	----
690404S	1/4" x 1/4"	0.10	----
690406S	1/4" x 3/8"	0.10	----
690602S	3/8" x 1/8"	0.10	----
690604S	3/8" x 1/4"	0.11	----
690606S	3/8" x 3/8"	0.12	----
690608S	3/8" x 1/2"	0.20	----
690804S	1/2" x 1/4"	0.16	----
690806S	1/2" x 3/8"	0.18	----
690808S	1/2" x 1/2"	0.26	----
691006S	5/8" x 3/8"	0.28	----
691008S	5/8" x 1/2"	0.30	----
691208S	3/4" x 1/2"	0.50	----
691212S	3/4" x 3/4"	0.56	----

AQ69DOTS 169PMT 1869 DQ69DOTS

WARNING: This product can expose you to chemicals, including lead, which are known to the State of California to cause cancer and birth defects or other reproductive harm. For more information, visit www.P65Warnings.ca.gov



D.O.T. PUSH-IN

TRUCK AND TRAILER

FEMALE ELBOW



Forged

AQ70DOTS
DQ70

PART #	TUBE O.D. X FEMALE NPTF	APPROX. WT. LBS.	
700402	1/4" x 1/8"	0.06	----
700404	1/4" x 1/4"	0.10	----
700406	1/4" x 3/8"	0.16	----
700602	3/8" x 1/8"	0.15	----
700604	3/8" x 1/4"	0.12	----
700606	3/8" x 3/8"	0.17	----
700806	1/2" x 3/8"	0.26	----
700808	1/2" x 1/2"	0.30	----

AQ70DOTS 1870 DQ70DOTS 170PMTNS

FEMALE SWIVEL ELBOW



AQ70DOTS

PART #	TUBE O.D. X FEMALE NPTF	
700404S	1/4" x 1/4"	----

MALE RUN TEE

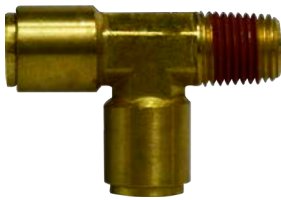

Forged

AQ71DOT
DQ71

PART #	TUBE O.D. X MALE NPTF (1 X 3) X 2	APPROX. WT. LBS.	
710402	1/4" x 1/8"	0.06	----
71040604	(1/4" x 3/8") x 1/4"	0.20	----
710404	1/4" x 1/4"	0.08	----
710604	3/8" x 1/4"	0.20	----
71060404	(3/8" x 1/4") x 1/4"	0.20	----
710606	3/8" x 3/8"	0.17	----
71060406	(3/8" x 1/4") x 3/8"	0.20	----
710608	3/8" x 1/2"	0.14	----
710806	1/2" x 3/8"	0.28	----

AQ71DOT 171PMTNS 1871 DQ71DOT

WARNING: This product can expose you to chemicals, including lead, which are known to the State of California to cause cancer and birth defects or other reproductive harm. For more information, visit www.P65Warnings.ca.gov

TRUCK & TRAILER

D.O.T. PUSH-IN

TRUCK AND TRAILER

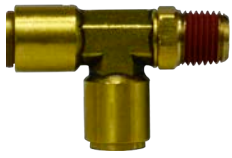
MALE SWIVEL RUN TEE

AQ71DOTS
DQ71S Forged

PART #	TUBE O.D. X MALE NPTF	APPROX. WT. LBS.	
710402S	1/4" x 1/8"	0.09	----
710404S	1/4" x 1/4"	0.11	----
710604S	3/8" x 1/4"	0.15	----
710606S	3/8" x 3/8"	0.14	----
710804S	1/2" x 1/4"	0.24	----
710806S	1/2" x 3/8"	0.24	----
710808S	1/2" x 1/2"	0.30	----

AQ71DOTS 171PMT 1871 DQ71DOTS

MALE 45° ELBOW

AQ54DOT
DQ54 Forged

PART #	TUBE O.D. X MALE NPTF	APPROX. WT. LBS.	
540402	1/4" x 1/8"	0.06	----
540404	1/4" x 1/4"	0.06	----
540602	3/8" x 1/8"	0.08	----
540604	3/8" x 1/4"	0.09	----
540606	3/8" x 3/8"	0.11	----
540608	3/8" x 1/2"	0.15	----
540804	1/2" x 1/4"	0.13	----
540806	1/2" x 3/8"	0.16	----
540808	1/2" x 1/2"	0.18	----
541006	5/8" x 3/8"	0.22	----
541008	5/8" x 1/2"	0.21	----
541208	3/4" x 1/2"	0.28	----
541212	3/4" x 3/4"	0.32	----

AQ54DOT 179MTNS 1880 DQ54DOT

MALE 45° SWIVEL ELBOW

AQ54DOTS
DQ54S

PART #	TUBE O.D. X MALE NPTF	APPROX. WT. LBS.	
540402S	1/4" x 1/8"	0.06	----
540404S	1/4" x 1/4"	0.09	----
540602S	3/8" x 1/8"	0.10	----
540604S	3/8" x 1/4"	0.11	----
540606S	3/8" x 3/8"	0.13	----
540804S	1/2" x 1/4"	0.14	----
540806S	1/2" x 3/8"	0.16	----
540808S	1/2" x 1/2"	0.18	----
541008S	5/8" x 1/2"	0.24	----

AQ54DOTS 179PMT 1880 DQ54DOTS

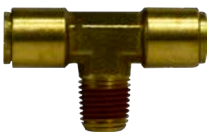
MALE BRANCH TEE

AQ72DOT
DQ72 Forged

PART #	TUBE O.D. X MALE NPTF (1 X 2) X 3	APPROX. WT. LBS.	
720302	3/16" x 1/8"	0.07	----
720402	1/4" x 1/8"	0.10	----
720404	1/4" x 1/4"	0.10	----
720604	3/8" x 1/4"	0.14	----
72060404	(3/8" x 1/4") x 1/4"	0.20	----
720606	3/8" x 3/8"	0.15	----
720804	1/2" x 1/4"	0.20	----
720806	1/2" x 3/8"	0.24	----
720808	1/2" x 1/2"	0.32	----

AQ72DOT 172PMTNS 1872 DQ72DOT

WARNING: This product can expose you to chemicals, including lead, which are known to the State of California to cause cancer and birth defects or other reproductive harm. For more information, visit www.P65Warnings.ca.gov



D.O.T. PUSH-IN

TRUCK AND TRAILER

MALE SWIVEL BRANCH TEE



AQ72DOTS
DQ72S

PART #	TUBE O.D. X MALE NPTF	APPROX. WT. LBS.	
720402S	1/4" x 1/8"	0.12	----
720404S	1/4" x 1/4"	0.14	----
720602S	3/8" x 1/8"	0.19	----
720604S	3/8" x 1/4"	0.15	----
720606S	3/8" x 3/8"	0.17	----
720804S	1/2" x 1/4"	0.30	----
720806S	1/2" x 3/8"	0.34	----
720808S	1/2" x 1/2"	0.22	----

AQ72DOTS 172PMT 1872 DQ72DOTS

FEMALE BRANCH TEE

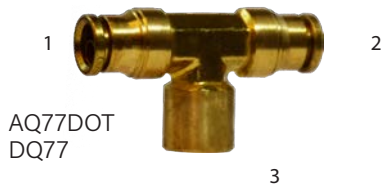

AQ77DOT
DQ77

(RUN) BRANCH

PART #	(1 & 2) X 3	
770402	1/4" x 1/8"	----
770404	1/4" x 1/4"	----
770604	3/8" x 1/4"	----

GLADHAND BULKHEAD CONNECTOR



TUBE OD X MALE NPTF

PART #	SIZE	
830808	1/2" x 1/2"	----

BULKHEAD UNION

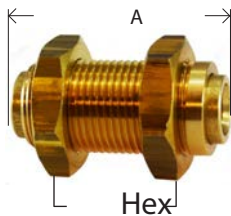

AQ82DOT
DQ82

PART #	TUBE O.D.	APPROX. WT. LBS.	
820400	1/4"	0.16	----
820600	3/8"	0.21	----
820800	1/2"	0.14	----
821000	5/8"	0.30	----

AQ82DOT 62PMTBH 1874 DQ82DOT

FEMALE BULKHEAD UNION



AQ86DOT
DQ86

PART #	TUBE O.D. X FEMALE NPTF	APPROX. WT. LBS.	
860402	1/4" x 1/8"	0.08	----
860404	1/4" x 1/4"	0.10	----
860604	3/8" x 1/4"	0.14	----
860606	3/8" x 3/8"	0.31	----
860808	1/2" x 1/2"	0.32	----

AQ86DOT 1873 DQ86DOT 66PMTBH

▪ Jam nuts not available separately

COMPOSITE BODY D.O.T. PUSH-IN
TRUCK AND TRAILER

COMPOSITE BODY DOT AIRBRAKE FITTINGS

WARNING

- Composite DOT push-to-connect fittings are designed only for use in applications where air is utilized as an operating fluid.
 - Fittings must be used in accordance with manufacturer and industry specifications.
 - They are not intended for use in environments exceeding 145psi or 140 degrees F.
 - The Department of Transportation FMVSS 49CFR571-106 prohibits use of this type of fitting for connections between towed and towing vehicles or between a driveshaft and chassis.
 - Using Composite DOT fittings in a manner inconsistent with manufacturer specifications may result in serious injury or property damage.
 - Under no circumstances shall the supplier be liable to buyer for any consequential or incidental damages of any nature whatsoever arising from nonconformity of goods, defective goods, or delay in shipment or any other breach by seller.
- Please feel free to email warning@compdotfitting.com with any questions or concerns.



- One touch connection reduces installation time and cost.
- Rugged ultraviolet and vibration resistant composite body.
- Various shapes and configurations to meet vehicle applications and make installations easier.

SPECIFICATIONS FOR FMVSS (D.O.T.) AND SAE COMPLIANT FITTINGS

Operating Fluid		Air					
Max. Operating Pressure	145psi (1.0MPa)						
Proof Pressure	Size	5/32"	1/4"	3/8"	1/2"	5/8"	3/4"
	At 75°F (24°C)	1200psi	1200psi	1400psi	950psi	900psi	800psi
	At 200 °F (93°C)	450psi (3.1MPa)					
Recommended Fluid and Ambient Temperature*	-40°F to 140°F (-40°C to 60°C)						
Leak Rate at -40°F (-40°C)	7 Ncm ³ /min. or less						
Thread	Thread Portion	ANSI/ASME B1.20.1, 1983 R1992					
	Nut	JIS B 0208 (Unified fine thread) ISO 263					
Thread Sealant	Fluorine/ Acrylic						
Applicable Standards	D.O.T. FMVSS 49 CFR 571.106, SAE J2494-3						
Applicable Tubing	Tubing conforming to both SAE J844 and D.O.T. FMVSS 49 CFR 571.106. Material: Nylon12						
Tube O.D.	5/32", 1/4", 3/8", 1/2", 5/8", 3/4"						

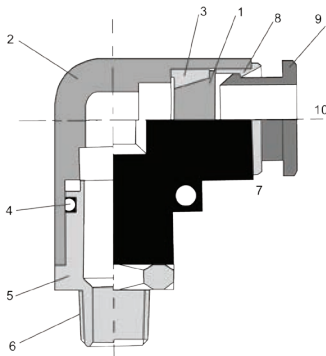

1. Chuck	Stainless steel or Brass
2. Body	Polybutylene Terephthalate (PBT), Brass
3/4. Tube seal, O-Ring	Buna-N, Nitrile Rubber
5. Stud	Brass
6. Sealant	Flourine/ Acrylic
7. Guide	Stainless Steel or Polyacetal (Acetal)
8. Stabilization Ring	Stainless Steel
9. Release Button	Polyacetal, POM (Acetal)
10. Tube support	Stainless Steel/ Brass

WARNING: This product can expose you to chemicals, including lead, which are known to the State of California to cause cancer and birth defects or other reproductive harm. For more information, visit www.P65Warnings.ca.gov

COMPOSITE BODY D.O.T. PUSH-IN

TRUCK AND TRAILER

STRAIGHT UNION



PART #	TUBE OD (INCH)	APPROX. WT. LBS.	
620532C	5/32	0.01	----
620400C	1/4	0.01	----
620600C	3/8	0.03	----
620800C	1/2	0.05	----
621000C	5/8	0.08	----

UNION TEE



PART #	TUBE OD (INCH)	APPROX. WT. LBS.	
645320C	5/32	0.02	----
640400C	1/4	0.02	----
640600C	3/8	0.05	----
640800C	1/2	0.07	----
641000C	5/8	0.13	----

UNION 90° ELBOW



PART #	TUBE OD (INCH)	APPROX. WT. LBS.	
655320C	5/32	0.01	----
650400C	1/4	0.02	----
650600C	3/8	0.04	----
650800C	1/2	0.05	----

FEMALE CONNECTOR



PART #	TUBE OD (INCH)	THREAD NPT	APPROX. WT. LBS.	
665302C	5/32	1/8-27	0.04	----
665304C	5/32	1/4-18	0.06	----
660402C	1/4	1/8-27	0.04	----
660404C	1/4	1/4-18	0.06	----
660406C	1/4	3/8-18	0.10	----
660602C	3/8	1/8-27	0.07	----
660604C	3/8	1/4-18	0.07	----
660606C	3/8	3/8-18	0.11	----
660608C	3/8	1/2-14	0.12	----
660802C	1/2	1/8-27	0.11	----
660804C	1/2	1/4-18	0.13	----
660806C	1/2	3/8-18	0.12	----
660808C	1/2	1/2-14	0.13	----

WARNING: This product can expose you to chemicals, including lead, which are known to the State of California to cause cancer and birth defects or other reproductive harm. For more information, visit www.P65Warnings.ca.gov

COMPOSITE BODY D.O.T. PUSH-IN

TRUCK AND TRAILER

STRAIGHT MALE CONNECTOR

PART #	APP. TUBE OD (INCH)	THREAD NPT	APPROX. WT. LBS.	
685301C	5/32	1/16-28	0.02	----
685302C	5/32	1/8-27	0.02	----
685304C	5/32	1/4-27	0.03	----
680402C	1/4	1/8-27	0.02	----
680404C	1/4	1/4-18	0.03	----
680406C	1/4	3/8-18	0.05	----
680602C	3/8	1/8-27	0.05	----
680604C	3/8	1/4-18	0.06	----
680606C	3/8	3/8-18	0.06	----
680608C	3/8	1/2-14	0.09	----
680804C	1/2	1/4-18	0.09	----
680806C	1/2	3/8-18	0.09	----
680808C	1/2	1/2-14	0.09	----
681006C	5/8	3/8-18	0.15	----
681008C	5/8	1/2-14	0.13	----
681208C	3/4	1/2-14	0.38	----

90° MALE ELBOW

- Fixed



PART #	TUBE OD (INCH)	THREAD NPT	APPROX. WT. LBS.	
695322SC	5/32	1/8-27	0.03	----
690402SC	1/4	1/8-27	0.03	----
690404SC	1/4	1/4-18	0.04	----
690406SC	1/4	3/8-18	0.07	----
690602SC	3/8	1/8-27	0.07	----
690604SC	3/8	1/4-18	0.06	----
690606SC	3/8	3/8-18	0.08	----
690608SC	3/8	1/2-14	0.14	----
690804SC	1/2	1/4-18	0.07	----
690806SC	1/2	3/8-18	0.09	----
690808SC	1/2	1/2-14	0.14	----
691006SC	5/8	3/8-18	0.14	----
691008SC	5/8	1/2-14	0.18	----
691208SC	3/4	1/2-14	0.26	----

90° FEMALE ELBOW

PART #	TUBE OD (INCH)	THREAD NPT	APPROX. WT. LBS.	
705302C	5/32	1/8-27	0.03	----
705304C	5/32	1/4-18	0.05	----
700402SC	1/4	1/8-27	0.03	----
700404SC	1/4	1/4-18	0.05	----
700406SC	1/4	3/8-18	0.08	----
700602C	3/8	1/8-27	0.05	----
700604SC	3/8	1/4-18	0.07	----
700606SC	3/8	3/8-18	0.09	----
700608SC	3/8	1/2-14	0.10	----
700804C	1/2	1/4-18	0.08	----
700806SC	1/2	3/8-18	0.10	----
700808SC	1/2	1/2-14	0.11	----

WARNING: This product can expose you to chemicals, including lead, which are known to the State of California to cause cancer and birth defects or other reproductive harm. For more information, visit www.P65Warnings.ca.gov

COMPOSITE BODY D.O.T. PUSH-IN

TRUCK AND TRAILER

MALE RUN TEE

- Fixed



PART #	TUBE OD (INCH)	THREAD NPT	APPROX. WT. LBS.	
715301C	5/32	1/16	0.05	----
715302C	5/32	1/8	0.03	----
715304C	5/32	1/4	0.04	----
710402SC	1/4	1/8-27	0.04	----
710404SC	1/4	1/4-18	0.05	----
710604SC	3/8	1/4-18	0.08	----
710606SC	3/8	3/8-18	0.10	----
710608SC	3/8	1/2-14	0.15	----
710804C	1/2	1/4-8	0.09	----
710806SC	1/2	3/8-18	0.11	----
710808C	1/2	1/2-14	0.17	----

MALE BRANCH TEE

- Fixed



PART #	TUBE OD (INCH)	THREAD NPT	APPROX. WT. LBS.	
725301C	5/32	1/16	0.03	----
725302C	5/32	1/8	0.03	----
725304C	5/32	1/4	0.05	----
720402SC	1/4	1/8-27	0.04	----
720404SC	1/4	1/4-18	0.05	----
720406SC	1/4	3/8-18	0.08	----
720604SC	3/8	1/4-18	0.08	----
720606SC	3/8	3/8-18	0.10	----
720608C	3/8	1/2-14	0.15	----
720804C	1/2	1/4-18	0.09	----
720806SC	1/2	3/8-18	0.11	----
720808SC	1/2	1/2-14	0.17	----
721006C	5/8	3/8	0.18	----
721008C	5/8	1/2	0.21	----

FEMALE BRANCH TEE



PART #	TUBE OD (INCH)	THREAD NPT	APPROX. WT. LBS.	
770402C	1/4	1/8-27	0.06	----
770404C	1/4	1/4-18	0.08	----
770604C	3/8	1/4-18	0.08	----
770806C	1/2	3/8	0.13	----
771004C	5/8	1/4	0.21	----

45° MALE ELBOW

- Fixed



PART #	TUBE OD (INCH)	THREAD NPT	APPROX. WT. LBS.	
545302C	5/32	1/8-27	0.03	----
540402SC	1/4	1/8-27	0.03	----
540404SC	1/4	1/4-18	0.04	----
540602SC	3/8	1/8-27	0.06	----
540604SC	3/8	1/4-18	0.06	----
540606SC	3/8	3/8-18	0.08	----
540608SC	3/8	1/2-14	0.13	----
540802C	1/2	1/8-27	0.08	----
540804SC	1/2	1/4-18	0.08	----
540806SC	1/2	3/8-18	0.10	----
540808SC	1/2	1/2-14	0.15	----
541006SC	5/8	3/8-18	0.14	----
541008SC	5/8	1/2-14	0.17	----
541208SC	3/4	1/2-14	0.26	----

WARNING: This product can expose you to chemicals, including lead, which are known to the State of California to cause cancer and birth defects or other reproductive harm. For more information, visit www.P65Warnings.ca.gov

COMPOSITE BODY D.O.T. PUSH-IN

TRUCK AND TRAILER

UNION "Y"

PART #	A&B TUBE OD (INCH)	C TUBE OD (INCH)	APPROX. WT. LBS.	
620553C	1/4	1/4	0.03	----
620409C	1/4	3/8	0.03	----
620555C	3/8	3/8	0.05	----
620559C	3/8	1/4	0.07	----
620557C	1/2	1/2	0.08	----

MALE BRANCH "Y"

PART #	TUBE OD (INCH)	THREAD NPT	APPROX. WT. LBS.	
880402C	1/4	1/8	0.05	----
880404C	1/4	1/4	0.06	----
880406C	1/4	3/8	0.09	----
620604C	3/8	1/4-18	0.09	----
620606C	3/8	3/8-18	0.12	----
620806C	1/2	3/8-18	0.13	----
620808C	1/2	1/2-14	0.15	----

BULKHEAD UNION

PART #	TUBE OD (INCH)	THREAD (UNF)	APPROX. WT. LBS.	
825320C	5/32	1/2-20	0.07	----
820400C	1/4	9/16-18	0.07	----
820600C	3/8	7/8-14	0.19	----
820800C	1/2	1-12	0.26	----
821000C	5/8	1 1/8-12	0.42	----

FEMALE BULKHEAD CONNECTOR

PART #	APP. TUBE OD (INCH)	THREAD NPT	T (UNF)	APPROX. WT. LBS.	
865304C	5/32	1/4-18	1/2-20	0.08	----
860402C	1/4	1/8-27	9/16-18	0.01	----
860404C	1/4	1/4-18	9/16-18	0.08	----
860604C	3/8	1/4-18	7/8-14	0.20	----
860606C	3/8	3/8-18	7/8-14	0.20	----
860806C	1/2	3/8-18	1-12	0.26	----
860808C	1/2	1/2-14	1-12	0.27	----



WARNING: This product can expose you to chemicals, including lead, which are known to the State of California to cause cancer and birth defects or other reproductive harm. For more information, visit www.P65Warnings.ca.gov

D.O.T. AIR BRAKE - NYLON TUBING

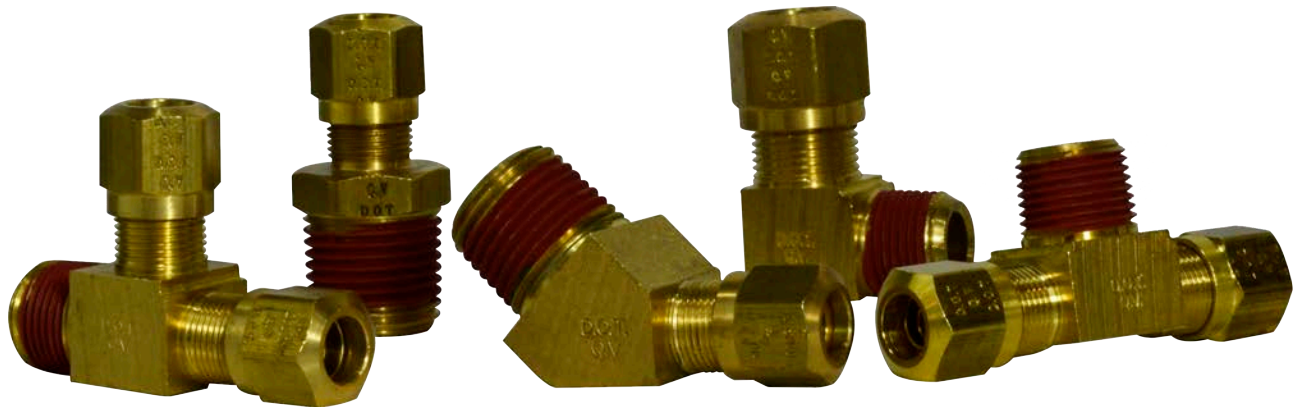

Tube O.D	1/4	3/8	1/2	5/8	3/4
Thread Size-B	7/16-24	17/32-24	11/16-20	13/16-18	1-18

-Typical Application

Air brake systems except where temperatures exceed +200°F or where battery acid can drip on tubing.

-Pressure

Maximum operating pressure of 150 PSI.

-Vibration

Fair resistance.

-Temperature Range

-40°F to +200°F (-40°C to +93°C).

-Material

Brass

-Used With

NT Nylon Tubing - SAE J844 Type A and B.

- Tolerance

+/- .02 on all dimensions. Dimension data can change without notice. Please call us when dimensions are critical

-Advantages

Easy to assemble (no tube preparation or flaring required.) Built in tube support. Fittings utilize a ribbed sleeve for compression and positive grip. May be used with copper tubing by replacing nut, sleeve and insert with long nut and spherical sleeve. Insert should be removed for copper tubing use.

-Conformance

Meets specifications and standards of SAE and DOT FMVSS 571,106.

-Assembly Instructions

- 1- Cut tubing to desired length.
- 2-Slide nut and then sleeve on tubing. Threaded end of nut "A" must face toward fitting body.
- 3-Insert tubing into the preassembled fitting. Be sure tubing is bottomed in fitting.
- 4- Tighten nut to required torque as indicated on chart.

Disassembling: Remove nut and pull tubing out of fitting body. Insert will remain in tubing.

Reassembly: Push tubing and insert into fitting body until it bottoms. Thread nut onto fitting body

Tube Size	Additional Number of Turns from Hand-Tight
1/4	3
3/8, 1/2	4
5/8, 3/4	3-1/2

WARNING: This product can expose you to chemicals, including lead, which are known to the State of California to cause cancer and birth defects or other reproductive harm. For more information, visit www.P65Warnings.ca.gov

D.O.T. AIR BRAKE - NYLON TUBING

TRUCK AND TRAILER

SLEEVE

SAE# 100115

60NA
NT60

PART #	TUBE O.D.	APPROX. WT. LBS.	
38000	3/16"		----
38001	1/4"	0.01	----
38002	3/8"	0.01	----
38003	1/2"	0.01	----
38004	5/8"	0.01	----
38005	3/4"	0.01	----

60NAB 60NTA 1460

NUT

SAE# 100110

62NA
NT61

PART #	TUBE O.D.	APPROX. WT. LBS.	
38009	3/16"		----
38010	1/4"	0.02	----
38011	3/8"	0.03	----
38012	1/2"	0.05	----
38013	5/8"	0.06	----
38014	3/4"	0.09	----

61NAB 61NTA 1461

UNION

SAE# 100101BA

62NA
NT62

PART #	TUBE O.D.	APPROX. WT. LBS.	
38018	3/16"		----
38019	1/4"	0.07	----
38020	3/8"	0.11	----
38021	1/2"	0.20	----
38022	5/8"	0.25	----
38023	3/4"	0.40	----

62NAB 62NTA 1462

BULKHEAD UNION62NABH
NT62BH

PART #	TUBE O.D.	APPROX. WT. LBS.	
38028	1/4"	0.11	----
38029	3/8"	0.16	----
38030	1/2"	0.26	----

62NBH 1474 475

STAINLESS STEEL INSERT

• 300 SERIES STAINLESS

• For SAE# J844 TUBING



61NSI

PART #	TUBE O.D.	APPROX. WT. LBS.	
38035	1/4"	0.01	----
38036	3/8"	0.01	----
38037	1/2"	0.01	----
38038	5/8"	0.01	----
38039	3/4"	0.01	----

59A 63NTA

BRASS INSERT

61NCI

PART #	TUBE O.D.	APPROX. WT. LBS.	
38040	1/4"	0.01	----
38041	3/8"	0.01	----
38042	1/2"	0.01	----
38043	5/8"	0.01	----
38048	3/4"	0.02	----

1484 463



D.O.T. AIR BRAKE - NYLON TUBING

TRUCK AND TRAILER

TEE

SAE# 100401BA



64NA
NT64

PART #	TUBE O.D.	APPROX. WT. LBS.	
38044	1/4"	0.12	----
38045	3/8"	0.19	----
38046	1/2"	0.36	----
38047	5/8"	0.48	----

64NAB 264NTA 1464

REDUCING BRANCH TEE

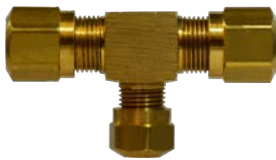

PART #	TUBE O.D. (1&2) X 3	APPROX. WT. LBS.	
38049	3/8" x 1/4"	0.24	----
38057	1/2" x 3/8"	0.30	----

ELBOW

SAE# 100201BA



65NA
NT65

PART #	TUBE O.D.	APPROX. WT. LBS.	
38052	1/4"	0.09	----
38053	3/8"	0.13	----
38054	1/2"	0.15	----
38055	5/8"	0.36	----

65NAB 265NTA 1465

FEMALE ADAPTER

SAE# 100103BA



66NA
NT66

PART #	TUBE O.D. X FEMALE NPT	APPROX. WT. LBS.	
38060	1/4" x 1/8"	0.06	----
38061	1/4" x 1/4"	0.08	----
38062	3/8" x 1/8"	0.07	----
38063	3/8" x 1/4"	0.10	----
38064	3/8" x 3/8"	0.14	----
38065	1/2" x 3/8"	0.16	----
38066	1/2" x 1/2"	0.20	----
38067	5/8" x 3/8"	0.28	----
38068	5/8" x 1/2"	0.28	----
38059	3/4" x 1/2"	0.31	----

66NAB 66NTA 1466 66NBH

Dimension data can change without notice. Please see our website when dimensions are critical.

Toll Free Phone 970-242-6810



sales@munrosupply.com

D.O.T. AIR BRAKE - NYLON TUBING

TRUCK AND TRAILER

MALE ADAPTER

SAE# 100102BA

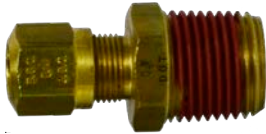
68NA
NT68VS

• More sizes available online

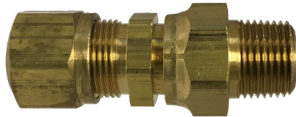
SWIVEL MALE ADAPTER

PART #	TUBE O.D. X MALE NPTF	APPROX. WT. LBS.	
38072	1/4" x 1/16"	0.05	----
38073	1/4" x 1/8"	0.05	----
38074	1/4" x 1/4"	0.06	----
38075	1/4" x 3/8"	0.08	----
38076	3/8" x 1/8"	0.07	----
38077	3/8" x 1/4"	0.08	----
38078	3/8" x 3/8"	0.10	----
38079	3/8" x 1/2"	0.14	----
38080	1/2" x 1/4"	0.13	----
38081	1/2" x 3/8"	0.14	----
38082	1/2" x 1/2"	0.18	----
38087	1/2" x 3/4"	0.23	----
38083	5/8" x 3/8"	0.17	----
38084	5/8" x 1/2"	0.21	----
38088	5/8" x 3/4"	0.25	----
38085	3/4" x 1/2"	0.28	----
38086	3/4" x 3/4"	0.30	----

68NAB 68NTA 1468

PART #	TUBE O.D. X MALE NPTF	APPROX. WT. LBS.	
38078S	3/8" x 3/8"	0.18	----
38081S	1/2" x 3/8"	0.22	----

MALE ELBOW

SAE# 100202BA

69NA
NT69VS

• More sizes available online

SWIVEL MALE ELBOW

PART #	TUBE O.D. X MALE NPTF	APPROX. WT. LBS.	
38091	1/4" x 1/8"	0.06	----
38092	1/4" x 1/4"	0.08	----
38093	1/4" x 3/8"	0.13	----
38094	3/8" x 1/8"	0.09	----
38095	3/8" x 1/4"	0.11	----
38090	3/8" x 1/4" LONG	0.14	----
38101	3/8" x 3/8"	0.14	----
38102	3/8" x 1/2"	0.20	----
38103	1/2" x 1/4"	0.16	----
38104	1/2" x 3/8"	0.20	----
38109	1/2" x 3/8" LONG	0.26	----
38105	1/2" x 1/2"	0.29	----
38106	5/8" x 3/8"	0.26	----
38107	5/8" x 1/2"	0.32	----
38110	5/8" x 3/4"	0.40	----
38108	3/4" x 1/2"	0.43	----
38111	3/4" x 3/4"	0.51	----

269NTA 1469

PART #	TUBE O.D. X MALE NPTF	APPROX. WT. LBS.	
38101S	3/8" x 3/8"	0.28	----
38104S	1/2" x 3/8"	0.32	----

FEMALE ELBOW

SAE# 100203BA

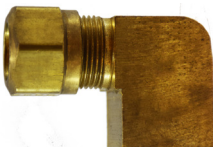
70NA
NT70

PART #	TUBE O.D. X FEMALE NPTF	APPROX. WT. LBS.	
38113	1/4" x 1/8"	0.08	----
38114	1/4" x 1/4"	0.12	----
38115	3/8" x 1/8"	0.14	----
38116	3/8" x 1/4"	0.10	----
38117	3/8" x 3/8"	0.12	----
38118	1/2" x 3/8"	0.23	----
38119	1/2" x 1/2"	0.36	----

WARNING: This product can expose you to chemicals, including lead, which are known to the State of California to cause cancer and birth defects or other reproductive harm. For more information, visit www.P65Warnings.ca.gov

D.O.T. AIR BRAKE - NYLON TUBING

TRUCK AND TRAILER

MALE RUN TEE

SAE# 100424BA

71NA
NT71VS



PART #	TUBE O.D. X MALE NPTF X TUBE O.D. 1X2X3	APPROX. WT. LBS.	
38125	1/4" x 1/8" x 1/4"	0.10	----
38126	1/4" x 1/4" x 1/4"	0.13	----
38124	3/8" x 1/4" x 1/4"	0.14	----
38127	3/8" x 1/4" x 3/8"	0.17	----
38128	3/8" x 3/8" x 3/8"	0.20	----
38129	1/2" x 3/8" x 1/2"	0.30	----

71NAB 271NTA 1471

MALE BRANCH TEE

SAE# 100425BA

72NA
NT72VS

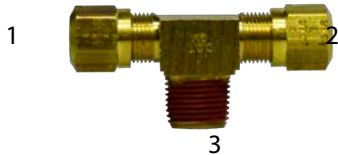

PART #	TUBE O.D. X TUBE O.D. X MALE NPTF 1X2X3	APPROX. WT. LBS.	
38136	1/4" x 1/4" x 1/8"	0.10	----
38137	1/4" x 1/4" x 1/4"	0.13	----
38138	3/8" x 3/8" x 1/8"	0.14	----
38132	3/8" x 1/4" x 1/4"	0.15	----
38139	3/8" x 3/8" x 1/4"	0.17	----
38133	1/2" x 1/2" x 1/4"	0.26	----
38140	3/8" x 3/8" x 3/8"	0.21	----
38134	1/2" x 3/8" x 3/8"	0.26	----
38141	1/2" x 1/2" x 3/8"	0.30	----
38142	1/2" x 1/2" x 1/2"	0.37	----
38143	5/8" x 5/8" x 1/2"	0.44	----

72NAB 272NTA 1472

FEMALE BRANCH TEE

1

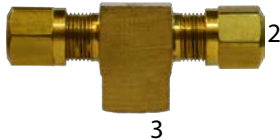

PART #	TUBE O.D. X TUBE O.D. X FEMALE NPTF 1X2X3	APPROX. WT. LBS.	
38144	3/8" x 3/8" x 1/4"	0.21	----
38146	5/8" x 5/8" x 1/4"	0.48	----

45° ELBOW

SAE# 100302BA

6945NA
NT6945VS



PART #	TUBE O.D. X MALE NPTF	APPROX. WT. LBS.	
38148	1/4" x 1/8"	0.06	----
38149	1/4" x 1/4"	0.08	----
38150	3/8" x 1/8"	0.09	----
38151	3/8" x 1/4"	0.11	----
38152	3/8" x 3/8"	0.14	----
38153	3/8" x 1/2"	0.24	----
38157	1/2" x 1/4"	0.18	----
38154	1/2" x 3/8"	0.19	----
38155	1/2" x 1/2"	0.25	----
38156	5/8" x 1/2"	0.30	----
38158	3/4" x 1/2"	0.38	----

6945NAB 279NTA 1480

SWIVEL 45° ELBOW

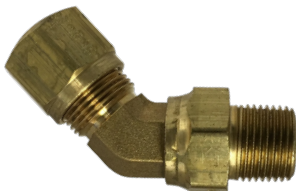

PART #	TUBE O.D. X MALE NPTF	APPROX. WT. LBS.	
38152S	3/8" x 3/8"	0.20	----
38154S	1/2" x 3/8"	0.24	----

D.O.T. AIR BRAKE - COPPER TUBING

TRUCK AND TRAILER

SLEEVE

SAE# 120115BA



60AB
AB60

PART #	TUBE O.D.	A	APPROX. WT. LBS.	
38161	1/4"	0.25	0.01	----
38162	3/8"	0.31	0.02	----
38163	1/2"	0.38	0.02	----
38164	5/8"	0.44	0.02	----
38165	3/4"	0.50	0.04	----

60AB 1360

NUT

SAE# 120111BA

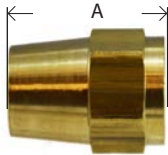

61AB
AB61

Hex

PART #	TUBE O.D.	A	HEX	APPROX. WT. LBS.	
38170	1/4"	0.75	0.56	0.02	----
38171	3/8"	1.13	0.62	0.04	----
38172	1/2"	1.25	0.81	0.08	----
38173	5/8"	1.38	0.94	0.12	----
38174	3/4"	1.56	1.12	0.18	----

20961 61AB 1361

UNION

SAE# 120101BA

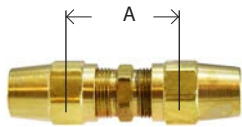

62AB
AB62

Hex

PART #	TUBE O.D.	A	HEX	APPROX. WT. LBS.	
38179	1/4"	0.81	0.44	0.08	----
38180	3/8"	1.10	0.56	0.14	----
38181	1/2"	1.07	0.69	0.24	----
38182	5/8"	1.41	0.81	0.34	----
38183	3/4"				----

62AB 1362

TEE

SAE# 120401BA

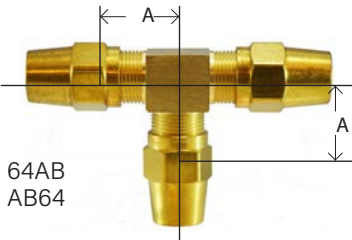

64AB
AB64

PART #	TUBE O.D.	A	APPROX. WT. LBS.	
38188	1/4"	0.62	0.16	----
38189	3/8"	0.82	0.24	----
38190	1/2"	0.94	0.48	----
38191	5/8"			

264AB 1364

ELBOW

SAE# 120201BA

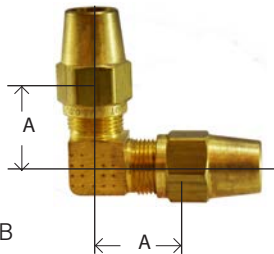

65AB
A65

PART #	TUBE O.D.	A	APPROX. WT. LBS.	
38196	1/4"	0.62	0.10	----

265AB 1365

WARNING: This product can expose you to chemicals, including lead, which are known to the State of California to cause cancer and birth defects or other reproductive harm. For more information, visit www.P65Warnings.ca.gov

D.O.T. AIR BRAKE - COPPER TUBING

TRUCK AND TRAILER

FEMALE ADAPTER

SAE# 120103BA

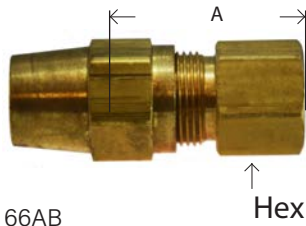

66AB
AB66

PART #	TUBE O.D. X FEMALE NPTF	A	HEX	APPROX. WT. LBS.	
38204	1/4" x 1/8"	0.84	0.56	0.08	----
38205	1/4" x 1/4"	1.07	0.68	0.10	----
38206	3/8" x 1/8"	1.00	0.56	0.10	----
38207	3/8" x 1/4"	1.19	0.68	0.12	----
38208	3/8" x 3/8"	1.18	0.87	0.16	----
38209	1/2" x 3/8"	1.27	0.87	0.18	----
38210	1/2" x 1/2"	1.44	1.06	0.20	----
38211	5/8" x 3/8"	1.31	0.87	0.24	----
38212	5/8" x 1/2"	0.50	1.06	0.26	----
38213	3/4" x 1/2"				----

66AB 1366

MALE ADAPTER

SAE# 120102BA

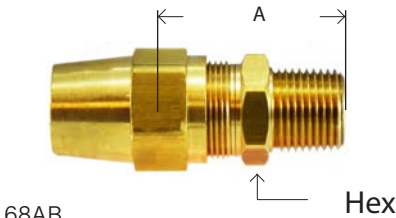

68AB
AB68

PART #	TUBE O.D. X MALE NPTF	A	HEX	APPROX. WT. LBS.	
38217	1/4" x 1/8"	0.88	0.43	0.06	----
38218	1/4" x 1/4"	0.97	0.56	0.08	----
38221	3/8" x 1/4"	1.09	0.56	0.10	----
38222	3/8" x 3/8"	1.19	0.69	0.12	----
38223	3/8" x 1/2"	1.45	0.87	0.18	----
38224	1/2" x 1/4"	1.32	0.69	0.16	----
38225	1/2" x 3/8"	1.35	0.69	0.18	----
38226	1/2" x 1/2"	1.51	0.87	0.24	----
38227	5/8" x 3/8"	1.39	0.81	0.22	----
38228	5/8" x 1/2"	1.57	0.87	0.24	----
38229	3/4" x 1/2"	1.67	1.00	0.34	----

68AB 368

90° MALE ELBOW

SAE# 120202BA

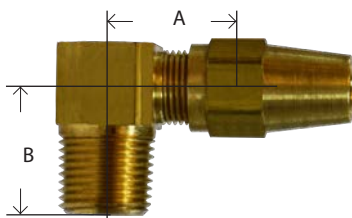

69AB
AB69

PART #	TUBE O.D. X MALE NPTF	A	B	APPROX. WT. LBS.	
38235	1/4" x 1/8"	0.64	0.76	0.08	----
38236	1/4" x 1/4"	0.69	0.88	0.10	----
38237	1/4" x 3/8"	0.73	0.86	0.14	----
38239	3/8" x 1/4"	0.80	0.93	0.12	----
38240	3/8" x 3/8"	0.83	0.90	0.16	----
38241	3/8" x 1/2"				----
38243	1/2" x 3/8"	0.92	0.98	0.22	----
38244	1/2" x 1/2"	1.04	1.19	0.30	----
38246	5/8" x 1/2"	1.10	1.25	0.36	----

269AB 1369

MALE BRANCH TEE

SAE# 120425BA

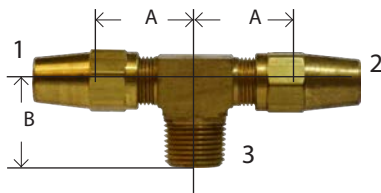

72AB
AB72

PART #	TUBE O.D. X MALE NPTF (1&2)X3	A	B	APPROX. WT. LBS.	
38278	3/8" x 1/4"	0.78	0.91	0.18	----
38279	3/8" x 3/8"	0.85	0.92	0.24	----

272AB 1372

WARNING: This product can expose you to chemicals, including lead, which are known to the State of California to cause cancer and birth defects or other reproductive harm. For more information, visit www.P65Warnings.ca.gov

TRUCK & TRAILER

D.O.T. AIR BRAKE - HOSE/ ENDS

TRUCK AND TRAILER

D.O.T. AIR BRAKE REUSABLE HOSE/ FITTINGS



•Typical Application

Air Brake hose connections.
Meets SAE & DOT specifications
(FMVCS 10 GAL)

•Pressure

Determined by maximum working pressure for hose size. Up to 125 psi

Temperature: -40°F to + 120° F (-40°C to +48°C)

•Advantages

Can be used for nearly any brake line. Easy to assemble with a good selection of hose end configurations. Brass material offers excellent resistance against corrosion.

• Tolerance

+/- .02 on all dimensions. Dimension data can change without notice. Please call us when dimensions are critical.

•Assembly Instructions

- 1- Slide nut and sleeve onto hose. Make sure bevel edge of sleeve faces out toward fitting.
- 2- Push hose into fitting until it bottoms.
- 3- Screw nut until contact is made with body hex.

NOTE: When reassembling fitting, body and nut should be inspected. Only reuse if in proper condition. Sleeves should never be reused.

SLEEVE

FERRULE

60HE
HE60



PART #	HOSE I.D. SIZE	APPROX. WT. LBS.	
38300	3/8"	0.02	----
38301	1/2"	0.02	----

#60HC 3380-A 0903610 367 60RB

NUT

61HE
HE61



PART #	HOSE I.D. SIZE	APPROX. WT. LBS.	
38306	3/8"	0.04	----
38307	1/2"	0.06	----

61RB #61HC 369 3380-B 0903624

NUT FOR USE WITH SPRING

61HES
HE61N



PART #	HOSE I.D. SIZE	THREAD	APPROX. WT. LBS.	
38312	3/8"	31/32-20	0.04	----
38313	1/2"	1-3/32-20	0.06	----

#61HCS 0903613 3380-D 61RB5G

D.O.T. AIR BRAKE - HOSE/ ENDS

TRUCK AND TRAILER

SPRING

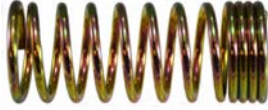

61HSG
HE61G

PART #	HOSE I.D.	APPROX. WT. LBS.	
38351	3/8"	0.20	----
38352	1/2"	0.22	----

#60SG 0901045 3380-C 377

NUT AND SPRING ASSEMBLY



HE61NG

PART #	HOSE I.D. SIZE	APPROX. WT. LBS.	
38015	3/8"	0.18	----
38016	1/2"	0.24	----

379 67RBSG 0999999

UNION



62HE
HE62

PART #	HOSE I.D.	THREAD	APPROX. WT. LBS.	
38318	3/8"	31/32-20	0.32	----
38319	1/2"	1-1/8-20	0.48	----

#62HC 3380B-Y0 362



BODY ONLY

PART #	HOSE I.D.	THREAD	APPROX. WT. LBS.	
39318	3/8"	31/32-20	0.32	----
39319	1/2"	1-1/8-20	0.48	----

FEMALE CONNECTOR HOSE



66HEA

PART #	HOSE I.D. X FEMALE ABS	APPROX. WT. LBS.	
38357	3/8" x 3/4-20	0.24	----
38358	1/2" x 7/8-20	0.39	----

#66ABS 66RBSV 3380B-Y7 386



BODY ONLY

PART #	HOSE I.D. X FEMALE ABS	APPROX. WT. LBS.	
39357	3/8" x 3/4-20	0.24	----
39358	1/2" x 7/8-20	0.38	----

MALE CONNECTOR



68HEA
HE68S

PART #	HOSE I.D. X MALE PIPE	APPROX. WT. LBS.	
38363	3/8" x 1/4"	0.38	----
38364	1/2" x 3/8"	0.46	----

#68ABS 09155 3380B-Y8 387

WARNING: This product can expose you to chemicals, including lead, which are known to the State of California to cause cancer and birth defects or other reproductive harm. For more information, visit www.P65Warnings.ca.gov

TRUCK & TRAILER

D.O.T. AIR BRAKE - HOSE/ENDS

TRUCK AND TRAILER

ADAPTER FOR SWIVEL TYPE REUSABLE AND CRIMPED68HEAB
1390

PART #	MALE ABS X MALE PIPE	ABS THREAD	APPROX. WT. LBS.	
38369	3/8" x 1/4"	3/4-20	0.05	----
38368	3/8" x 3/8"	3/4-20	0.08	----
38372	3/8" x 1/2"	3/4-20	0.12	----
38370	1/2" x 3/8"	7/8-20	0.10	----
38371	1/2" x 1/2"	7/8-20	0.12	----

#68ABS 1390 76RB 388

MALE ADAPTER68HE
HE68

PART #	HOSE I.D. X MALE PIPE	APPROX. WT. LBS.	
38333	3/8" x 1/4"	0.22	----
38334	3/8" x 3/8"	0.24	----
38335	3/8" x 1/2"	0.26	----
38336	1/2" x 3/8"	0.33	----
38337	1/2" x 1/2"	0.36	----

#68HC 368 3380B-Y2 68RB

ADAPTER BODY68HEB
HE68B

PART #	HOSE I.D. X MALE PIPE	APPROX. WT. LBS.	
38324	3/8" x 1/4"	0.12	----
38325	3/8" x 3/8"	0.14	----
38326	3/8" x 1/2"	0.20	----
38327	1/2" x 3/8"	0.18	----
38328	1/2" x 1/2"	0.20	----

#68B W1391Z

MALE ADAPTER68HES
HE68G

PART #	HOSE I.D. X MALE PIPE	APPROX. WT. LBS.	
38342	3/8" x 1/4"	0.32	----
38343	3/8" x 3/8"	0.34	----
38344	3/8" x 1/2"	0.38	----
38345	1/2" x 3/8"	0.48	----
38346	1/2" x 1/2"	0.52	----

#68HCS 3380B-Y3 68RBSG 378

WARNING: This product can expose you to chemicals, including lead, which are known to the State of California to cause cancer and birth defects or other reproductive harm. For more information, visit www.P65Warnings.ca.gov



STEEL GREASE FITTINGS

TRUCK AND TRAILER

- 8000 PSI MAX. PRES-
- EXCEEDS 12HR SALT

Meets SAE #J-534C

• ASSORTMENTS ALSO

Many types available on special order.

• SEE WEBSITE FOR GREASE ACCESS-

PIPE THREAD

BALL CHECK - 1/8"-27 NPTF

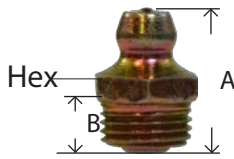

PART #	SIZE	A	B	HEX	APPROX. WT. LBS.	
36110	1/8" -27 NPTF	0.66	0.28	0.437	0.01	----
36110SS	303 SS	0.68	0.29	0.437	0.01	----
36111	Thread Forming	0.62	0.23	0.437	0.01	----

#610 1610 2800 1720 5000

PIPE THREAD

BALL CHECK

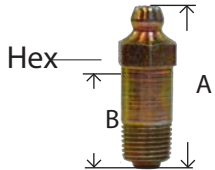

PART #	SIZE	A	B	HEX	APPROX. WT. LBS.	
36112	1/8" -27 NPTF	1.25	0.22	0.437	0.02	----
36113	1/8" -27 NPTF	1.75	1.26	0.437	0.02	----

#607 1607 2800 1669 5003

PIPE THREAD

30° ANGLE BALL CHECK

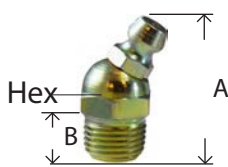

PART #	SIZE	A	B	HEX	APPROX. WT. LBS.	
36114	1/8" -27 NPTF	0.90	0.30	0.437	0.01	----

#611 1611 2830 5100

PIPE THREAD

45° ANGLE BALL CHECK

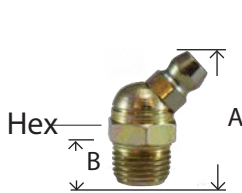

PART #	SIZE	A	B	HEX	APPROX. WT. LBS.	
36116	1/8" -27 NPTF	0.88	0.22	0.437	0.01	----
36116SS	303 SS	0.95	0.29	0.437	0.01	----

#688 1688 2845 5200

PIPE THREAD

65° ANGLE BALL CHECK

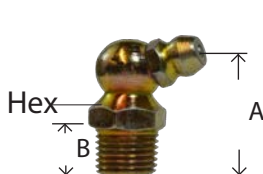

PART #	SIZE	A	B	HEX	APPROX. WT. LBS.	
36118	1/8" -27 NPTF	0.86	0.30	0.437	0.01	----

#612 1612 2865 5300

PIPE THREAD

90° ANGLE BALL CHECK

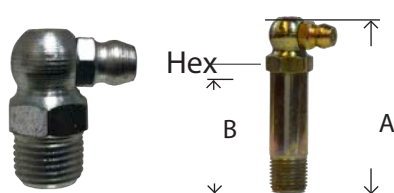

PART #	SIZE	A	B	HEX	APPROX. WT. LBS.	
36120	1/8" -27 NPTF	0.84	0.30	0.437	0.01	----
36120SS	303 SS	0.84	0.29	0.437	0.01	----
36121	1/8" -27 NPTF	1.81	1.25	0.437	0.01	----

#613 1613 2890 5400 5407

PIPE THREAD

BALL CHECK - 1/4"-18 NPTF

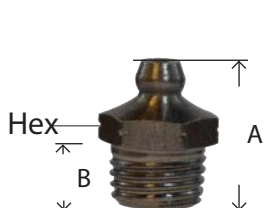

PART #	SIZE	A	B	HEX	APPROX. WT. LBS.	
36130	1/4" -18 NPTF	0.84	0.30	0.437	0.02	----
36130SS	303 SS	0.87	0.42	0.437	0.02	----

#627 1627 2900K 5050

WARNING: This product can expose you to chemicals, including lead, which are known to the State of California to cause cancer and birth defects or other reproductive harm. For more information, visit www.P65Warnings.ca.gov

STEEL GREASE FITTINGS

TRUCK AND TRAILER

PIPE THREAD

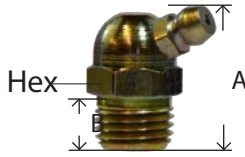

65° ANGLE BALL CHECK

PART #	SIZE	A	B	HEX	APPROX. WT. LBS.	
36132	1/4"-18 NPTF	0.97	0.34	0.56	0.02	----

#629 1629 2965 5350

1/4-28 TAPER THREAD

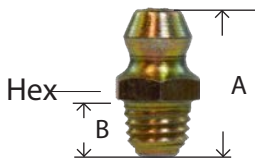

SHORT BALL CHECK - 1/4-28 NPTF

PART #	SIZE	A	B	HEX	APPROX. WT. LBS.	
36140	1/4"-28 NPTF	0.54	0.18	0.31	0.01	----
36140SS	303 SS	0.54	0.18	0.31	0.01	----
36141	Thread Forming	0.55	0.10	0.31	0.01	----

#641 1641 2400 3038 5010

1/4-28 TAPER THREAD

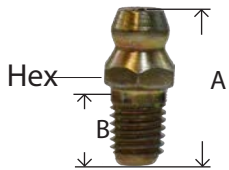

LONG BALL CHECK

PART #	SIZE	A	B	HEX	APPROX. WT. LBS.	
36142	1/4"-28 Taper Thread	0.69	0.34	0.312	0.01	----

#652 1652 2400 5013

1/4-28 TAPER THREAD

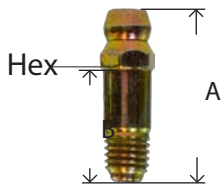

EXTRA LONG BALL CHECK

PART #	SIZE	A	B	HEX	APPROX. WT. LBS.	
36144	1/4"-28 Taper Thread	0.92	0.60	0.312	0.02	----

#680 1680 2400 5014

1/4-28 TAPER THREAD

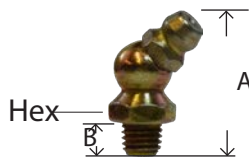

SHORT 45° BALL CHECK

PART #	SIZE	AN- GLE	A	B	HEX	APPROX. WT. LBS.	
36146	1/4"-28 Taper Thread	45°	0.82	0.20	0.375	0.02	----
36146SS	303 SS	45°	0.81	0.20	0.375	0.02	----

#637 1637 2445 1665 2465 3010 5210

1/4-28 TAPER THREAD

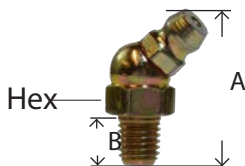

LONG 45° BALL CHECK

PART #	SIZE	A	B	HEX	APPROX. WT. LBS.	
36148	1/4"-28 Taper Thread	0.94	0.30	0.375	0.02	----

#636 1630 2445

1/4-28 TAPER THREAD

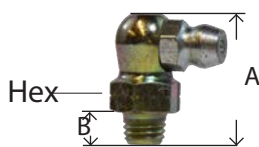

90° ANGLE BALL CHECK

SAE# A515002

PART #	SIZE	A	B	HEX	APPROX. WT. LBS.	
36150	1/4"-28 Taper Thread	0.75	0.10	0.375	0.02	----
36150SS	303 SS	0.75	0.20	0.375	0.02	----
36152	Thread Forming	0.75	0.16	0.375	0.02	----

#911 1911 2490 3054 5410

WARNING: This product can expose you to chemicals, including lead, which are known to the State of California to cause cancer and birth defects or other reproductive harm. For more information, visit www.P65Warnings.ca.gov

STEEL GREASE FITTINGS

TRUCK AND TRAILER

DRIVE TYPE BALL CHECK Drive Type

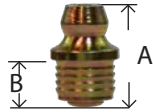

PART #	SIZE	A	B	APPROX. WT. LBS.	
36160	5/16"	0.55	0.25	0.01	----

#608 1608 5021

DRIVE TYPE BALL CHECK

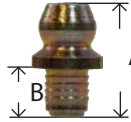

PART #	SIZE	A	B	APPROX. WT. LBS.	
36164	3/16"	0.52	0.25	0.01	----
36164SS	303 SS	0.51	0.25	0.01	----

#728 1728 2316 5033

DRIVE TYPE BALL CHECK

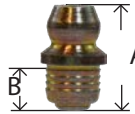

PART #	SIZE	A	B	APPROX. WT. LBS.	
36166	1/4"	0.55	0.23	0.01	----
36166SS	303 SS	0.55	0.23	0.01	----

#743 1743 214 5029

METRIC

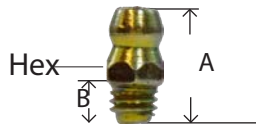

PART #	SIZE	A (MM)	B (MM)	HEX (MM)	APPROX. WT. LBS.	
36168	6MM x 1	16	3.7	7	0.01	----

(Diameter x Pitch)

#711 6000 2106 2M6 5175

METRIC 45° ANGLE

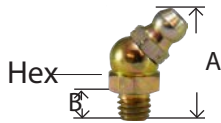

PART #	SIZE	A (MM)	B (MM)	HEX (MM)	APPROX. WT. LBS.	
36170	6MM x 1	21	3.7	9	0.02	----

#712 6045 2107 5176

METRIC 90° ANGLE

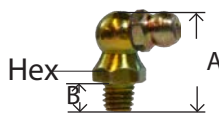

PART #	SIZE	A (MM)	B (MM)	HEX (MM)	APPROX. WT. LBS.	
36172	6MM x 1	18	3.7	9	0.02	----

#713 6090 2108 ZM906 5177

METRIC

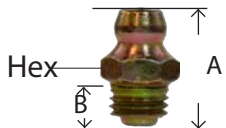

PART #	SIZE	A (MM)	B (MM)	HEX (MM)	APPROX. WT. LBS.	
36174	8MM x 1	16	3.7	9	0.02	----

#811 8000 2103 ZM58 5178

METRIC 45° ANGLE

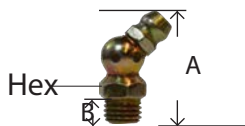

PART #	SIZE	A (MM)	B (MM)	HEX (MM)	APPROX. WT. LBS.	
36176	8MM x 1	21	3.7	9	0.02	----

#812 8045 2104 ZM458 5179

METRIC

90° ANGLE

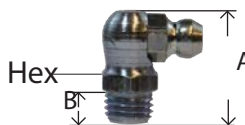

PART #	SIZE	A (MM)	B (MM)	HEX (MM)	APPROX. WT. LBS.	
36178	8MM x 1	18	3.7	9	0.02	----

#813 8090 2105 ZM908 5180

WARNING: This product can expose you to chemicals, including lead, which are known to the State of California to cause cancer and birth defects or other reproductive harm. For more information, visit www.P65Warnings.ca.gov

TRUCK & TRAILER

STEEL GREASE FITTINGS

TRUCK AND TRAILER

METRIC

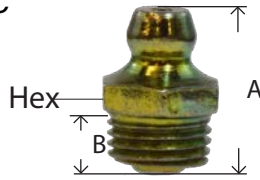

PART #	SIZE	A (MM)	B (MM)	HEX (MM)	APPROX. WT. LBS.	
36180	10MM x 1	16	3.7	11	0.02	----

• DIAMETER X PITCH (EXTRA FINE) #911 9000 2109 ZM510 5181

METRIC

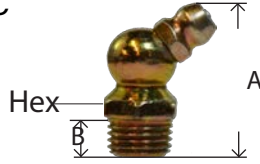

45° ANGLE

PART #	SIZE	A (MM)	B (MM)	HEX (MM)	APPROX. WT. LBS.	
36182	10MM x 1	21	3.7	11	0.02	----

#912 9045 2110 ZM4510

METRIC

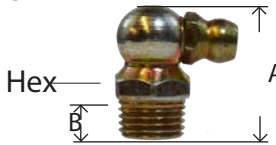

90° ANGLE

PART #	SIZE	A (MM)	B (MM)	HEX (MM)	APPROX. WT. LBS.	
36184	10MM x 1	18	3.7	11	0.02	----

#913 9090 2111 ZM9010 5183

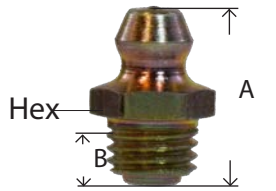

PART #	SIZE	A	B	HEX	APPROX. WT. LBS.	
36186	5/16"-24	0.65	0.12	0.375	0.02	----

#711-B 1711 2500

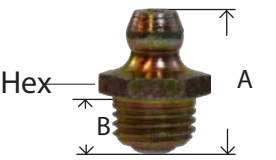

PART #	SIZE	A	B	HEX	APPROX. WT. LBS.	
36188	3/8"-24	0.65	0.14	0.437	0.01	----

#710-B 1710 2600

BUTTON HEAD

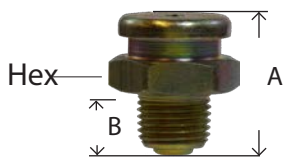

PART #	SIZE	A	B	HEX	APPROX. WT. LBS.	
36200	1/8"-27 PTF	0.75	0.34	0.625	0.03	----
36205	1/4"-18 NPT	0.83	0.44	0.625	0.03	----

1184 1186

WHIP HOSE - EXCEEDS SAE 100R1-AT - USE WITH HAND GREASE GUNS ONLY 10,000 PSI BURST PRESSURE RUB-



1/8" NPT SOLID
3/16" ID

3,000 PSI WORKING PRESSURE

PART #	LENGTH	
36210	12" RUBBER	----
36212	18" RUBBER	----
36214	24" RUBBER	----
36216	36" RUBBER	----

4 JAW GREASE GUN COUPLER

PROVIDES QUICK, POSITIVE, LEAKPROOF CONNECTION W/ GREASE

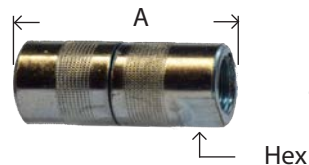

1/8" NPTF

Hex

PART #	A	HEX	APPROX. WT. LBS.	
36220	1.50	0.56	0.05	----

WARNING: This product can expose you to chemicals, including lead, which are known to the State of California to cause cancer and birth defects or other reproductive harm. For more information, visit www.P65Warnings.ca.gov

STEEL GREASE FITTINGS

TRUCK AND TRAILER

ADAPTERS FOR GREASE FITTINGS

ADAPTERS

• CARBON STEEL, ZINC COATED



PART #	FEMALE	MALE	L	H	WEIGHT	
36300	1/8"-27 NPTF	1/4"-28" SAE-LT	.75	1/2	0.02	----
36301	1/8"-27 NPTF	1/4"-28" SAE-LT	.87	1/2	0.02	----



PART #	FEMALE ENGLISH TO MALE ENGLISH	L	H	WEIGHT		
36304	1/4"-28 UNF	M6 x 1.0	.43	9mm	0.01	----
36305	1/4"-28 UNF	M8 x 1.0	.45	3/8	0.01	----
36306	1/4"-28 UNF	M10 x 1.0	.32	7/16	0.01	----

EXTENSIONS



PART #	FEMALE ENGLISH TO MALE ENGLISH	L	H	WEIGHT		
36307	1/4"-28 UNF	1/4"-28 SAE-LT	1.34	-	0.01	----
36308	1/8"-27 NPTF	1/8"-27 NPTF	.75	1/2	0.02	----
36309*	1/8"-27 NPTF	1/8"-27 NPTF	.82	1/2	0.02	----
36310	1/8"-27 NPTF	1/8"-27 NPTF	.94	9/16	0.04	----
36311	1/8"-27 NPTF	1/8"-27 NPTF	1.25	1/2	0.04	----

*BRASS PLATED

45° ANGLE ELBOWS



PART #	FEMALE	MALE	L	H	WEIGHT	
36360	1/8"-27 NPTF	1/4"-28 SAE-LT	.81	1/2	0.02	----
36362	1/8"-27 NPTF	1/8"-27 PTF SAE Short	1.00	1/2	0.03	----

90° ANGLE ELBOWS



PART #	FEMALE	MALE	L	H	WEIGHT	
36370	1/8"-27 NPTF	1/4"-28 SAE-LT	.81	1/2	0.03	----
36371	1/8"-27 NPTF	1/4"-28 SAE-LT	1.04	1/2	0.03	----
36372	1/8"-27 NPTF	1/4"-18 PTF SAE Short	1.19	9/16	0.06	----
36374	1/8"-27 NPTF	1/8"-27 PTF SAE Short	1.00	1/2	0.03	----
36375	1/8"-27 NPTF	1/8"-27 NPTF	1.13	1/2	0.03	----
36377	1/4"-18 NPTF	1/4"-18 NPTF	1.34	11/16	0.08	----
36376	1/8"-27 NPTF	1/8"-27 NPTF	1.50	5/8	0.07	----
36373	1/8"-27 PTF SPL Extra Short	1/8"-27 PTF SPL Extra Short	.82	1/2	0.03	----

COUPLING



PART #	FEMALE	FEMALE	L	H	WEIGHT	
36340	1/4"-28 UNF	1/8"-27 NPTF	.65	1/2	0.02	----

BULKHEAD CONNECTOR



PART #	FEMALE	MALE (FEMALE)	L	H	WEIGHT	
36350	1/8"-27 NPTF	1/8"-27 NPSM (1/4"-28 UNF)	.88	1/2	0.03	----

WARNING: This product can expose you to chemicals, including lead, which are known to the State of California to cause cancer and birth defects or other reproductive harm. For more information, visit www.P65Warnings.ca.gov

TRUCK & TRAILER

SPECIALTY VALVES
TRUCK AND TRAILER

SPECIALTY VALVES AND COCKS



DRAIN COCKS



AIR VALVES



3, 4 AND 6 WAY

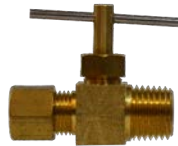

NEEDLE



MARINE & ANTI-SIPHON



PANEL MOUNT BALL VALVES



TRUCK



MINI BALL



SOLID BOTTOM SHUT-OFF



CHECK

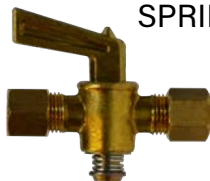

SPRING BOTTOM SHUT-OFF

WARNING: This product can expose you to chemicals, including lead, which are known to the State of California to cause cancer and birth defects or other reproductive harm. For more information, visit www.P65Warnings.ca.gov

DRAIN COCKS

TRUCK AND TRAILER

DRAIN COCKS

- For use with low pressure air, water and fluids.
- Designed for a working pressure of 150 psi @ 250°.
- Hand-tightening provides a metal-to-metal seal.
- Not intended for natural gas, LPG, nuclear or aircraft applications.

Install on your tank for easy draining

GASOLINE SHUT OFF W/ SCREEN FILTER

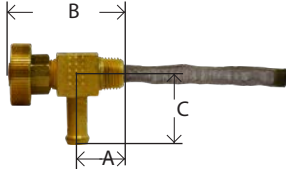

PART #	BARB X MALE PIPE	A	B	C	APPROX. WT. LBS.	
46064	1/4" x 1/8"	0.55	1.34	0.66	0.06	----

827

DRAIN COCK 150 PSI - TRUNK AIR TANK

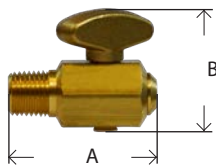

PART #	MALE PIPE	A	B	APPROX. WT. LBS.	
46066	1/4"	1.73	1.41	0.22	----

DCR601-4

TRUCK DRAIN - 125 P.S.I.G

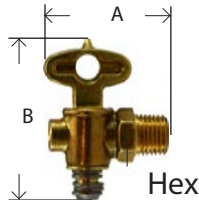

PART #	MALE PIPE	INDUS-TRY NUMBER	A	B	HEX	APPROX. WT. LBS.	
46067	1/8"		1.53	1.95	0.62	0.14	----

SHUT OFF - 150 P.S.I MAX.

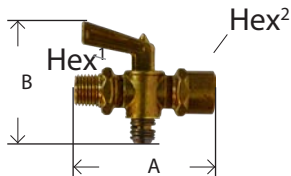

PART #	MALE PIPE X FEMALE PIPE	INDUS-TRY NUMBER	A	B	HEX 1	HEX 2	APPROX. WT. LBS.	
46069	1/4"	W20332	1.96	1.96	0.75	0.62	0.20	----

#60HC 3380-A 0903610 367

LEVER HANDLE

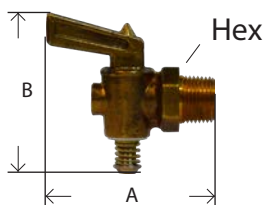

PART #	MALE PIPE	INDUS-TRY NUMBER	A	B	HEX	APPROX. WT. LBS.	
46070	1/8"	M-41-P	1.99	1.80	0.62	0.04	----
46071	1/4"	M-42-P	2.06	1.81	0.62	0.06	----
46072	3/8"	M-43-P	2.30	2.29	0.81	0.08	----
46073	1/2"	M-44-P	3.00	2.50	0.87	0.16	----

- 30 psi

840 41D DC601

*Valve is closed when handle is in the position of the picture

AIR TANK DRAIN PULL VALVE



PART #	SIZE	DESCRIPTION	
39595	1/4" male	5ft nylon coated pull cable	----
39596	1/4" male	4ft nylon coated pull cable	----
39597	1/4" male	3ft nylon coated pull cable	----
39600	1/4" male	Air valve only	----

DRAIN COCKS

TRUCK AND TRAILER

INTERNAL SEAT

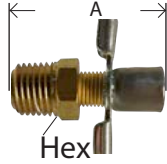

PART #	MALE PIPE	INDUSTRY NUMBER	A	HEX	APPROX. WT. LBS.	
46079	1/8"	6783	1.45	0.55	0.02	----

DC602 808 400A 1800A

INTERNAL SEAT - WING NUT HANDLE

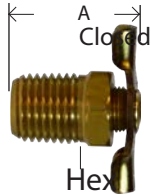

PART #	MALE PIPE	INDUSTRY NUMBER	A	HEX	APPROX. WT. LBS.	
46074	1/8"	130	0.92	0.40	0.04	----
46075	1/4"	140	0.94	0.56	0.06	----
46077	3/8"	230	1.27	0.68	0.08	----

HB - 5/16 803 305A

LONG INTERNAL SEAT

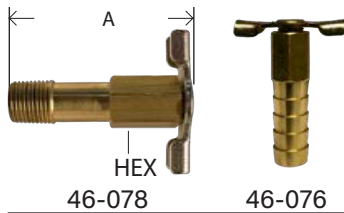

PART #	SIZE	IND #	A	HEX	APPROX. WT. LBS.	
46078	1/8 MIP	1.85				----
46076	3/8" Hose I.D.		1.65	0.43	0.02	----

809

PIN HANDLE - INTERNAL SEAT

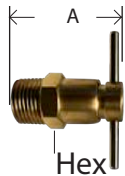

PART #	MALE PIPE	INDUSTRY NUMBER	A	HEX	APPROX. WT. LBS.	
46080	1/8"	M-200-P	1.22	0.50	0.04	----
46081	1/4"	M-201-P	1.31	0.56	0.06	----
46082	3/8"	M-202-P	1.53	0.68	0.12	----

DC603 802

EXTERNAL SEAT W/ SPOUT

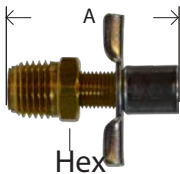

PART #	MALE PIPE	INDUSTRY NUMBER	A	HEX	APPROX. WT. LBS.	
46084*	1/4"	6788	1.56	0.56	0.02	----

* Replaces GM # 511771 & Chrysler #836015

200A 239 DC606 807

BIBB VALVE



PART #	MALE PIPE	INDUSTRY NUMBER	A	B*	C	APPROX. WT. LBS.	
46088	1/8"	150	0.82	1.60	0.55	0.04	----
46089	1/4"	120	0.89	1.59	0.54	0.06	----
46089A	1/4"	6660	0.55	1.34	0.66	0.06	----

* With valve closed

804 DC607 2019 201DH

RADIATOR TYPE - EXTERNAL SEAT



PART #	MALE PIPE	INDUSTRY NUMBER	IND #	A	HEX	APPROX. WT. LBS.	
46085	1/8"	M-320-P	135	0.90	0.43	0.02	----
46086	1/4"	M-321-P	145	1.00	0.56	0.04	----
46087	3/8"	M-322-P	270	1.25	0.68	0.08	----
46083	1/2"	108	108	1.48	0.87	0.12	----

320D 240 DC604 801

WARNING: This product can expose you to chemicals, including lead, which are known to the State of California to cause cancer and birth defects or other reproductive harm. For more information, visit www.P65Warnings.ca.gov

SHUT-OFF COCKS

TRUCK AND TRAILER

- Designed for working pressure of 30 PSI.
- Forged brass bodies and brass handles.
- Instantaneous off-on operation with 360° rotation.
- Not good for gasoline.

COMPRESSION X MALE PIPE

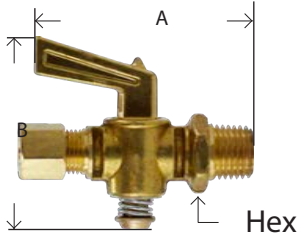

PART #	COMP X MALE PIPE	IND. #	A	B	HEX	APPROX. WT. LBS.	
46130	1/4" x 1/8"	27-C	1.87	1.81	0.51	0.14	----
46131	1/4" x 1/4"	227-C	2.05	1.86	0.62	0.15	----
46132	5/16" x 1/8"	29-C	2.05	1.90	0.50	0.16	----
46134	3/8" x 1/4"	57-C	2.05	1.83	0.62	0.15	----

868 V304C 2068 133C VC206

COMPRESSION X COMPRESSION

* See pg. 73-74 to order nut and sleeve separately.

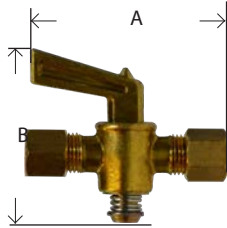

PART #	COMP X COMP	IND. #	A	B	APPROX. WT. LBS.	
46140	1/4"	28-C	1.82	1.84	0.12	----
46141	5/16"	30-C	1.84	1.88	0.14	----
46142	3/8"	58-C	1.87	1.80	0.14	----
46143	1/2"	68-C	2.21	2.32	0.22	----

V3030F 2062 134C

FEMALE X FEMALE PIPE

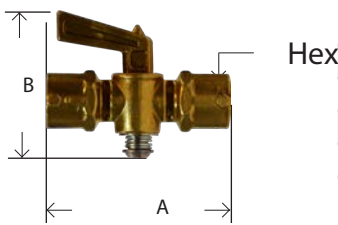

PART #	FEMALE PIPE X FEMALE PIPE	A	B	HEX	APPROX. WT. LBS.	
46151	1/8"	1.77	1.79	0.56	0.12	----
46152	1/4"	2.28	1.82	0.69	0.20	----
46152T*	1/4"	2.28	2.00	0.68	0.20	----
46153	3/8"	2.44	2.28	0.81	0.30	----

* 150 PSI

V403P 132C 875

MALE PIPE X FEMALE

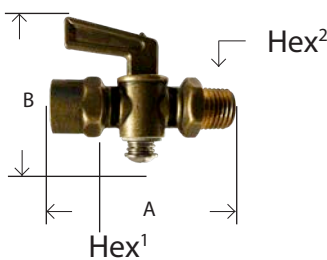

PART #	MALE PIPE X FEMALE PIPE	IND. #	A	B	HEX 1	HEX 2	APPROX. WT. LBS.	
46160	1/8"	48-P	2.03	1.84	0.50	0.56	0.14	----
46161	1/4"	49-P	2.26	1.79	0.69	0.69	0.18	----
46161T*	1/4"		2.26	1.98	0.69	0.69	0.20	----
46162	3/8"	50-P	2.33	2.28	0.82	0.82	0.28	----

* 150 PSI

880 V402P 130C

MALE PIPE X MALE PIPE

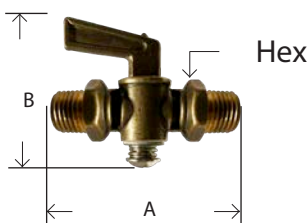

PART #	MALE PIPE X MALE PIPE	IND. #	A	B	HEX	APPROX. WT. LBS.	
46165	1/8"	76-P	2.15	1.80	0.69	0.12	----
46166	1/4"	77-P	2.22	1.84	0.70	0.17	----
46166T*	1/4"		2.23	2.00	0.68	0.18	----
46167	3/8"	78-P	2.43	2.24	0.82	0.22	----

* 150 PSI

1V401P 890

WARNING: This product can expose you to chemicals, including lead, which are known to the State of California to cause cancer and birth defects or other reproductive harm. For more information, visit www.P65Warnings.ca.gov

TRUCK & TRAILER

NEEDLE VALVES

TRUCK AND TRAILER

NEEDLE VALVES

THESE ARE NOT LEAD FREE SEE PAGES 169 FOR LEAD FREE PRODUCTS

Made with either pin handle or pressed on handle. Please specify if you have a preference.

- Used on instrumentation, hydraulic, and pneumatic systems.
- Designed for a maximum working pressure of 150 PSI. or

- Provided with steel handles and metal-to-metal seats with fine-thread screwdown.
- Not designed for natural gas, LPG, nuclear aircraft applications.
- Always install with pressure against the seat.

COMP X MALE PIPE

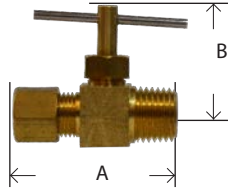

PART #	COMP X MALE PIPE	IND. #	A	B	APPROX. WT. LBS.	
46002	1/4" x 1/8"	M-101-C	1.29	1.12	0.07	----
46003	1/4" x 1/4"	M-101-C	1.27	1.14	0.10	----

NV106C 2205 820 3068

COMP X MALE PIPE-ANGLE

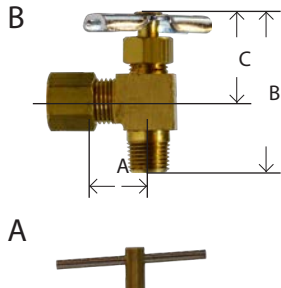

PART #	COMP X MALE PIPE	HANDLE	IND. #	A	B	C	APPROX. WT. LBS.	
46011	1/4" x 1/8"	A	M-103-C	0.56	1.48	0.93	0.08	----
46011X	Heavy Pattern	B	M-103-C	0.53	1.53	0.83	0.08	----
46012	1/4" x 1/4"	B	M-104-C	0.62	1.67	0.90	0.13	----
46013	5/16" x 1/8"	B	M-104-C	0.63	1.63	0.95	0.10	----

NV104C 2203 821 3069

COMP X COMP

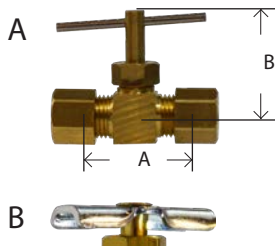

PART #	COMP X COMP	HANDLE	IND. #	A	B	APPROX. WT. LBS.	
46020	3/16"	B	M-105-C	1.06	0.88	0.08	----
46021	1/4"	A	M-106-C	1.17	1.12	0.10	----
46022	5/16"	A	M-107-C	1.22	1.08	0.12	----
46023	3/8"	B	M-113-C	1.31	1.15	0.13	----

NV105C 3062 2201 822

FLARE X MALE PIPE

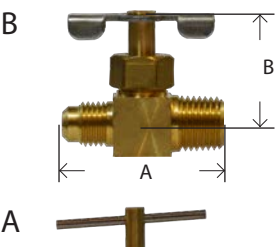

PART #	MALE FLARE X MALE PIPE	HANDLE	IND. #	A	B	APPROX. WT. LBS.	
46028	1/4" x 1/8"	A	M-104-SAE	1.35	1.12	0.07	----
46029	1/4" x 1/4"	B	M-1040-SAE	1.38	0.88	0.09	----
46031	3/8" x 1/4"	B	M-108-SAE	1.73	1.22	0.18	----

NV103F 2405 823 3048

WARNING: This product can expose you to chemicals, including lead, which are known to the State of California to cause cancer and birth defects or other reproductive harm. For more information, visit www.P65Warnings.ca.gov

NEEDLE VALVES

TRUCK AND TRAILER

FLARE X MALE PIPE

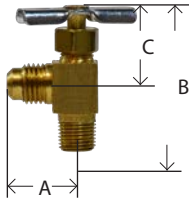

PART #	MALE FLARE X MALE PIPE	IND. #	A	B	C	APPROX. WT. LBS.	
46036	1/4" x 1/8"	M-103-SAE	0.68	1.54	0.86	0.08	----
46038	5/16" x 1/8"	M-203-SAE	0.88	1.59	0.94	0.11	----
46039	5/16" x 1/4"	M-204-SAE	0.90	1.94	1.00	0.14	----
46040	3/8" x 1/4"	M-303-SAE	0.95	1.86	0.90	0.17	----

NV101F 2403 824 3049

FLARE X FLARE

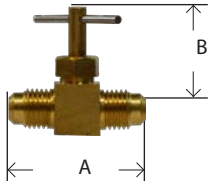

PART #	MALE FLARE X MALE FLARE	IND. #	A	B	APPROX. WT. LBS.	
46045	1/4"	M-110-SAE	1.48	1.20	0.18	----
46046	3/8"	M-115-SAE	1.79	1.19	0.20	----

NV102F 3042 825 2401

MULTI-PURPOSE AIR VENT

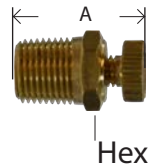

PART #	MALE PIPE	A	HEX	APPROX. WT. LBS.	
46048	1/8"	0.78	0.43	0.02	----

705

MALE PIPE TO MALE PIPE

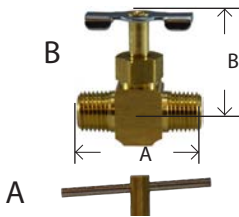

PART #	MALE PIPE X MALE PIPE	HANDLE	IND. #	A	B	APPROX. WT. LBS.	
46050	1/8"	A	M-108-P	1.25	1.09	0.08	----
46051	1/4"	B	M-110-P	1.69	1.00	0.16	----

NV107P 2301 826 3122

FEMALE PIPE X FEMALE PIPE

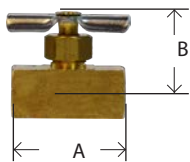

PART #	FEMALE PIPE X FEMALE PIPE	IND. #	A	B	APPROX. WT. LBS.	
46055*	1/8"	M-304-P	1.18	0.84	0.18	----
46056	1/4"	M-3044-P	1.60	1.24	0.21	----
46056P*	1/4" Heavy	M-3044-P	1.62	2.53	0.20	----

* Pressed on handle

6800 NV109P 2304 817 3103

MALE X FEMALE PIPE

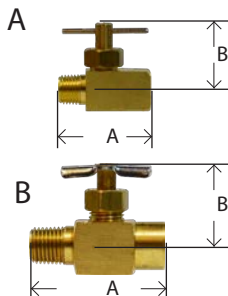

NBR seals -30°C to 120°C

PART #	MALE PIPE X FEMALE PIPE	HANDLE	IND. #	A	B	APPROX. WT. LBS.	
46060	1/8"	A	M-305-P	1.18	1.09	0.10	----
46061	1/4"	A	M-3055-P	1.60	1.14	0.18	----
46061L	1/4" Light Pattern	B	M-3055-P	1.88	1.09	0.21	----

NV108P 2305 818 3120

WARNING: This product can expose you to chemicals, including lead, which are known to the State of California to cause cancer and birth defects or other reproductive harm. For more information, visit www.P65Warnings.ca.gov

TRUCK & TRAILER

SPECIALTY VALVES

TRUCK AND TRAILER

BRASS TRUCK VALVES

- Used in heavy duty truck, trailer and mobile markets.
- Used on water, oil and coolant lines.
- Forged brass construction with steel handle.
- Temperature range -40° - 250°
- Max pressure 250 psi
- Metal to metal seats for high heat/ fluid compatibility
- Fine thread screw down to afford flow control ability and a positive seal.
- Not intended for natural gas, LPG, Nuclear or aircraft applications

200 PSI



TV44

BARB TO MALE PIPE

PART #	SIZE	
46450	3/8 x 3/8	----
46451	5/8 x 3/8	----
46455	5/8 x 1/2	----
46457	3/4 x 3/8	----
46456	3/4 x 1/2	----

404V



TV45

FEMALE TO MALE PIPE

PART #	SIZE	
46465	3/8 x 3/8	----
46466	3/8 x 1/2	----
46467	1/2 x 1/2	----

405V

TV49



FLARE TO MALE PIPE

PART #	SIZE	
46475	1/2 x 1/2	----
46476	5/8 x 1/2	----

409V

TV412



MIP X FLARE

PART #	SIZE	
46485	1/2 x 5/8	----

SOLID BOTTOM VALVES

- Designed for instantaneous on-off operation.
- 360° rotation standard.
- 30 PSI
- Packed with grease.



8875

O-RING SEALED MIP X FIP

PART #	SIZE	
46400	1/8	----
46401	1/4	----
46402	3/8	----

1035D M-70-SBV

- Good for Propane



#M-72-SBV FIP X FIP

PART #	SIZE	
46411	1/4	----

SOLID BOTTOM FUEL VALVES

- Approved for use on Motorcraft fuel lines.
- Pointer lever.
- 90° turn stop mechanism to assure positive location of the on and off positions.
- Corrosion proofed internal construction assures maximum salt atmosphere protection.
- Port hole is 1/4 (.250) diameter.
- UL listed for use in fuel oils no. 1 & no. 2, LP gas and utility gas.



PIPE MALE X FEMALE

PART #	SIZE	
46400M	1/8 x 1/8	----
46401M	1/4 x 1/4	----
46402M	3/8 x 3/8	----

8980



PIPE MALE X MALE

PART #	SIZE	
46406M	1/4 x 1/4	----

8990

- Good for Propane



PIPE FEMALE X FEMALE

PART #	SIZE	
46411M	1/4 x 1/4	----

8975



MALE PIPE X FLARE

PART #	SIZE	
46429M	1/4 x 3/8	----
46430M	3/8 x 3/8	----

8948

WARNING: This product can expose you to chemicals, including lead, which are known to the State of California to cause cancer and birth defects or other reproductive harm. For more information, visit www.P65Warnings.ca.gov

SPECIALTY VALVES

TRUCK AND TRAILER

GROUND PLUG SHUT-OFF COCKS

NON-LUBRICATED PLUG VALVES are designed to operate in systems where INSTANTANEOUS PORT SELECTION is desired. Since LUBRICANTS ARE NOT USED, relubrication is not required. There is no lubricant to freeze and lock the valve or to contaminate fine fluids. The O-RING SEALED CAP and STEM eliminate leakage to atmosphere. The mating BRASS BODY and CELCON PLUG produce a fine seal that WILL NOT SEIZE OR GALL.

Designed for PANEL or BRACKET MOUNTING. They are generally recommended for operation in GASOLINE, OIL, AIR, WATER and DETERGENT systems from minus 40° to 180°F, at a maximum operating pressure of 30 p.s.i.g. The fluid port size is 9/32 (.281) diameter for 1/8 and 1/4 sizes, 5/16 (.312) diameter for the 3/8 size. **(Consult factory for applications)**

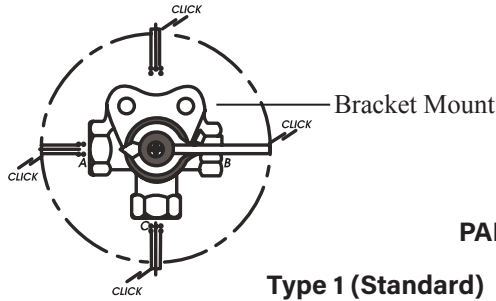

PANEL MOUNTING AVAILABLE

Type 1 (Standard)

A pronounced "click" may be felt at each position.

THREE-WAY VALVES (Side Outlet)

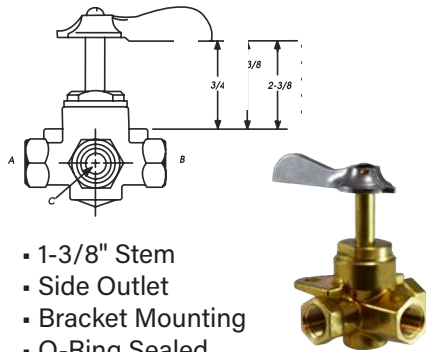

- 1-3/8" Stem
- Side Outlet
- Bracket Mounting
- O-Ring Sealed
- 4-way celcon roter standard

LESS CLICK

PART #	A-B-C FEMALE PIPE THREAD	LENGTH OF STEM	
46247	1/4	1-3/8"	----
46248	3/8	1-3/8"	----

M-108-MID WITH CLICK 360°

PART #	A-B-C FEMALE PIPE THREAD	LENGTH OF STEM	
46250	1/8	1-3/8"	----
46251	1/4	1-3/8"	----
46252	3/8	1-3/8"	----

V406P 6749

Openings:

- Handle Pointer over A.....Valve Open A-C
- Handle Pointer over C.....Valve Open B-C
- Handle Pointer over B.....Valve "OFF"
- Handle Pointer over Bracket.....Valve "OFF"

THREE-WAY VALVES (Bottom Outlet)

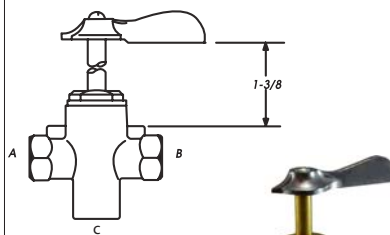

- 1-3/8" Stem
- Side Outlet
- Bracket Mounting
- O-Ring Sealed
- 4-way celcon roter standard

LESS CLICK

PART #	A-B-C FEMALE PIPE THREAD	LENGTH OF STEM	
46241	1/4	1-3/8"	----

WITH CLICK 360°

PART #	A-B-C FEMALE PIPE THREAD	LENGTH OF STEM	
46243	1/8	1-3/8"	----
46244	1/4	1-3/8"	----

Openings:

- Handle Pointer over A.....Valve Open A-C
- Handle Pointer over B.....Valve Open B-C
- Handle Pointer over Bracket.....Valve "OFF"

FOUR-WAY VALVES

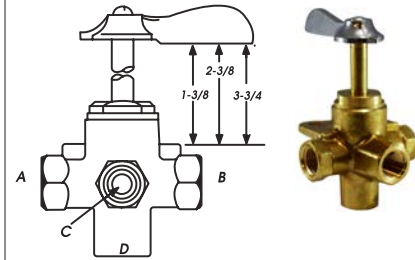

- Side Outlet
- Bracket Mounting
- O-Ring Sealed
- 4-way celcon roter standard

LESS CLICK

PART #	A-B-C-D FEMALE PIPE THREAD	LENGTH OF STEM	
46257	1/4	1-3/8"	----

M-114-MID WITH CLICK (360°)

PART #	A-B-C-D FEMALE PIPE THREAD	LENGTH OF STEM	
46255	1/4	1-3/8"	----
46256	3/8	1-3/8"	----

WITH 2-3/8" LONG STEM M-115-MID

Part #	A-B-C-D Female Pipe Thread	Length of Stem	
46260	1/4	2-3/8"	----

Openings:

- Handle Pointer over A.....Valve Open A-D
- Handle Pointer over C.....Valve Open C-D
- Handle Pointer over B.....Valve Open B-D
- Handle Pointer over Bracket.....Valve "OFF"

TRUCK AND TRAILER



INDUSTRY GRADE NYLON AIR COIL ASSEMBLY - SET

- Each kit contains one Emergency (Red) and one service (Blue) 1/2" O.D. nylon tubing assembly.
- 1/2" -14 NPTF end fitting with heavy gauge spring.
- Assemblies meet SAE J844 and DOT FMVSS 106 requirements.
- Temp rating -40° - +208°

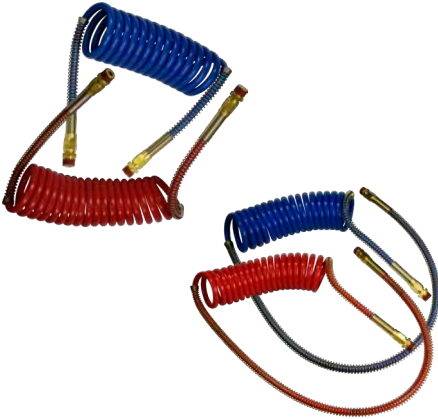

PART #	LENGTH	PIGTAIL LENGTH TRACTOR END	PIGTAIL LENGTH TRAILER END	
39404	12'	6"	6"	----
39400	15'	12"	12"	----
39402	15'	40"	12"	----
39406	20'	12"	12"	----

FIFTH WHEEL SLIDER COIL

- Temperatures range -40 to 208°F
- 150 psi max pressure rating
- Meets SAE J844 and DOT FMVSS 106 requirements.
- (2) 1/4" OD fittings assembled



PART #	DESCRIPTION	LENGTH	FITTINGS	
39839	5th Wheel slider coil	up to 54"	(2) 1/4" MPT	----
39838	5th Wheel slider coil	up to 72"	(2) 1/4" MPT	----

3-IN-1 AND 4-IN-1 COMBINATION AIRLINE CABLE

- (2) 3/8" ID SAE J1402 rubber service and emergency with blue (service) and red (emergency) gladhand grip handle
- Color-coded grip helps to minimize incorrect tractor/trailer connections have glad handle with Vibraseal
- ABS power line (green) – meets SAE J2222 requirements
- Auxiliary power line (yellow) – fitted with SAESS60 plugs that have an inverted (male) ground pin 4-in-1 only
- SAE J560 Plugs with sleeves for superior corrosion protection and strain relief
- Corrosion resistant all brass fittings 1/2" male NPT w/ Vibraseal
- Tapered grip flexes with airline during tight turns for kink protection
- Temp rating -40 - 208°F



PART #	DESCRIPTION	
39825	Combo 3 in 1 assembly 15 ft.	----
39962	Combo 4 in 1 assembly 15 ft.	----

WARNING: This product can expose you to chemicals, including lead, which are known to the State of California to cause cancer and birth defects or other reproductive harm. For more information, visit www.P65Warnings.ca.gov

HOSE SUPPORT



AIRBRAKE HOSE REPAIR KIT

- Fittings to repair hose with a minimum 3/4" OD
- Meets DOT 106 SAE j1402
- Brass sleeve and barb
- Pre-applied sealant

PART #	DESCRIPTION	
39855	3/8" Quick fix hose fitting	----
*39856	3/8" Quick fix hose kit- clam pack	----
39857	1/2" Quick fix hose fitting	----

*Supplied with hex tool



39425

39426

POGO STICKS CANNISTER STYLE

- Large diameter housing eliminates spring binding
- Increased resistance to sagging and bending
- Thick gauge heavy duty spring
- Used for all nylon and rubber air brake hose
- Forged steel mounting stud 7/16-20 thread
- All Pogo Sticks include Eyebolt and Nut

PART #	SIZE	DESCRIPTION	
39425	40"	Chrome finish	----
39426	40"	Zinc Plated Steel	----

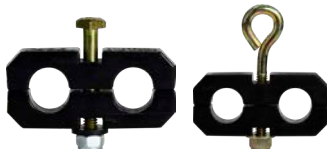

39409

39410

HOSE HOLDERS

- ABS Plastic
- 2, 3 and 4 Hold

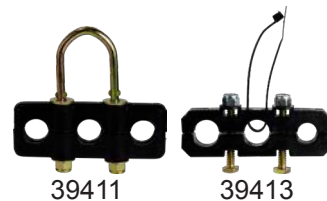

39411

39413

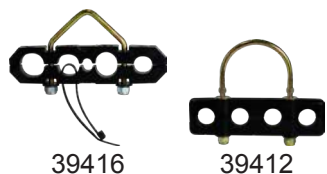

39416

39412

PART #	SIZE	DESCRIPTION	
39409	1/2"	2-Hose Holder Hex Head	----
39410	1/2"	2-Hose Holder	----
39411	1/2"	3-Hose Holder	----
39413	1/2"	3-Hose Hex Head w Cable tie	----
39416	1/2"	4-Hose V Bolt w Cable Tie	----
39412	1/2"	4-Hose Holder	----

HOSE SEPARATORS

- ABS Plastic



39415

39418

PART #	SIZE	DESCRIPTION	
39414	3/8"	2-Hose Separator	----
39415	3/8"	4-Hose Separator	----
39418	1/2"	2-Hose Separator	----
39419	1/2"	4-Hose Separator	----

HOSE SUPPORT

TRUCK AND TRAILER



39469



39473



39472



39411

TENDER KIT COMPONENTS

PART #	DESCRIPTION	
39411	3 hole holder	----
39469	Clip Carabiner	----
39472	1-1/2" ID Hanger Bracket	----
39473	Yoke	----

• Sold individually



39477

39471

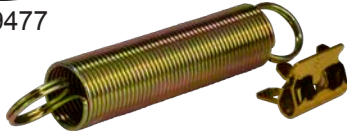

39463

SPRING WITH TANDEM FRAME CLIP

- Steel spring and clip - yellow dichromate finish
- 3/4" OD
- Beam clip

PART #	DESCRIPTION	
39477	Frame Clip with Cable Tie	----

PART #	LENGTH	DESCRIPTION	
39463	6" Spring	Tandem frame clip	----
39464	3" Spring	Tandem frame clip	----
39471		Frame clip only	----



95631

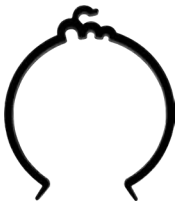

95640

CLIPS

PART #	DESCRIPTION	
95631	ABS Clip for 1/2" Air Hose	----
95640	5" Axle Clip	----
95641	5-3/4" Axle Clip	----

WARNING: This product can expose you to chemicals, including lead, which are known to the State of California to cause cancer and birth defects or other reproductive harm. For more information, visit www.P65Warnings.ca.gov

HOSE SUPPORT

TRUCK AND TRAILER



TENDER KIT

Complete Tender Kit includes:

- Large snap Clip
- Heavy duty spring
- Protective tube

PART #	SPRING & TUBE LENGTH/ #PCS	ONE CLIP	3 HOLE CLAMP	YOKE	
39442	16" / 1pc	1pc	1pc		----
39444	16" / 2 pcs	1pc	1pc	2pcs	----
39446	20" / 1pc	1pc	1pc		----
39448	20" / 2pcs	1pc	1pc	2pcs	----
39452	25" / 1pc	1pc	1pc		----
39453	25" / 2pcs	1pc	1pc	2pcs	----

HYDRAULIC TENDER KIT

PART #	SPRING & TUBE LENGTH/ #PCS	LARGE CLIP	HANGER BRACKET	YOKE	
39457	25" / 2pcs	1pcs	1pc	2pcs	----



SLIDER BAR KITS

PART #	SPRING & TUBE LENGTH/ #PCS	LARGE CLIP	3 HOLE CLAMP	SLIDER BAR LENGTH	YOKE	
39437	16" / 1pc	1pc	1pc	43"		----
39438	16" / 2pcs	1pc	1pc	43"	2pcs	----
39459	20" / 2pcs	1pc	1pc	43"	2pcs	----
39460	25" / 1pc	1pc	1pc	43"		----
39461	25" / 2pcs	1pc	1pc	43"	2pcs	----
39470	16" / 1pc	1pc	1pc	38"		----
39462	16" / 2pcs	1pc	1pc	38"	2pcs	----
39451	25" / 1pc	1pc	1pc	38"		----
39454	25" / 2pcs	1pc	1pc	38"	2pcs	----



BARS, SPRINGS, TUBES

PART #	SPRING & TUBE LENGTH/ #PCS	
39443	16" Tube only	----
39447	20" Tube only	----
39436	25" Tube only	----
39466	16" Spring only	----
39467	20" Spring only	----
39468	25" Spring only	----
39474	38" Slider Bar	----
39475	43" Slider Bar	----

WARNING: This product can expose you to chemicals, including lead, which are known to the State of California to cause cancer and birth defects or other reproductive harm. For more information, visit www.P65Warnings.ca.gov

GLADHANDS

ALUMINUM GLADHANDS

- 1/2 " FPT port
- Aluminum Casting
- Permanent Clamp Screw
- Black rubber seals
- Stainless Steel filter
- Meet SAE J318 requirements



PORT A

PART #	DESCRIPTION	MATERIAL	SEAL	FILTER	PORT A	
39870	Universal	Aluminum	Blk Rubber	No	1/2"	----
39871	Universal with filter	Aluminum	Blk Rubber	Yes	1/2"	----
39877	Emergency Red	Aluminum	Blk Rubber	No	1/2"	----
39878	Emergency with filter	Aluminum	Blk Rubber	Yes	1/2"	----
39874	Service Blue	Aluminum	Blk Rubber	No	1/2"	----
39875	Service with filter	Aluminum	Blk Rubber	Yes	1/2"	----

PLATED ALUMINUM GLADHANDS



PART #	DESCRIPTION	MATERIAL	SEAL	FILTER	PORT A	
39832	Universal Standard	Plated Aluminum	Blk Rubber	No	1/2"	----
39833	Service - Blue	Plated Aluminum	Blk Rubber	No	1/2"	----
39834	Emergency - Red	Plated Aluminum	Blk Rubber	No	1/2"	----
39828	Service 38 degree	Plated Aluminum	Blk Rubber	No	1/2"	----
39829	Emergency 38 degree	Plated Aluminum	Blk Rubber	No	1/2"	----
39830	Service 38 degree	Plated Aluminum	Blk Rubber	No	3/8"	----
39831	Emergency 38 degree	Plated Aluminum	Blk Rubber	No	3/8"	----

CAST IRON GLADHANDS

- 1/2 " FPT port
- One-piece casting eliminates problems with clamp separation
- "Positive-stop" post, assures a perfect connection
- Polyurethane seal resist oils, chemicals & provide improved sealing & service life
- Gladhands meet SAE J318 requirements including breakaway requirement.

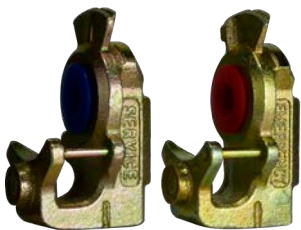

PORT A

PART #	DESCRIPTION	MATERIAL	SEAL	FILTER	PORT A	
39506	Universal	Cast Iron	Black Polyurethane	No	1/2"	----
39507	Emergency	Cast Iron	Red Polyurethane	No	1/2"	----
39508	Service	Cast Iron	Blue Polyurethane	No	1/2"	----

ANGLE MOUNT ALUMINUM GLADHANDS

- For use in trailer mounting locations
- Dual port provides connection options
- Powder-coated clamp plates are color coded for easy identification
- Port "A" comes standard as unplugged
- (2) 3/8 inch FPT Ports (one plugged).
- (2) 11/32 inch diameter mounting holes.
- Available with Port "B" plugged or unplugged (plug is included, loose in bag)
- Meet SAE J318



PORT A

PORT B

PART #	TYPE	MATERIAL	SEAL	FILTER	PORT A	PORT B	
39511	Emergency	Aluminum	Blk Rubber	No	Unplugged	Plugged	----
39512	Service	Aluminum	Blk Rubber	No	Unplugged	Plugged	----

WARNING: This product can expose you to chemicals, including lead, which are known to the State of California to cause cancer and birth defects or other reproductive harm. For more information, visit www.P65Warnings.ca.gov



PORT A

POWDER COATED IRON GLADHAND

- Tough powder coating improves wear & corrosion resistance
- Vividly colored to provide improved identification of service & emergency lines
- Stainless steel plate eliminates corrosion of the mating surface
- Polyurethane seal resist oil, chemicals, provide improved sealing & service life
- Meet or exceeds SAE J318 standard

PART #	DESCRIPTION	FILTER	PORT A
39509	Service with blue poly seal	Yes	1/2" ----
39510	Emergency with red poly seal	Yes	1/2" ----



BRACKET MOUNT SWING AWAY GLADHAND

- Bracket allows 180° rotation allowing for easy hookups, eliminating the need to twist lines during connections
- Helps protect rear-trailer gladhands when not in use
- Filter and closed seal are recommended
- Spring design provides consistent tension throughout rotation
- Design provides both back port and bottom port capabilities
Gladhand mount - 1/2" Male Thread

PART #	DESCRIPTION	MATERIAL	SEAL	FILTER
39515	Service (Blue)	Aluminum	Blk Rubber	yes ----
39516	Emergency (Red)	Aluminum	Blk Rubber	yes ----



KNOB STYLE SHUTOFF GLADHAND

- Economical trailer shutoff gladhand
- Centered low-profile "snap-stop" knob
- Full face rubber seal
- Available with assembled or separate fittings.
- Meets SAE J318

PART #	DESCRIPTION	MATERIAL	SEAL	FILTER
39520	1/2" Service (Blue)	Aluminum	Blk Rubber	No ----
39521	3/8" Service (Blue)	Aluminum	Blk Rubber	No ----
39522	1/2" Emergency (Red)	Aluminum	Blk Rubber	No ----
39524	3/8" Emergency (Red)	Aluminum	Blk Rubber	No ----



PORT A

LEVER STYLE SHUTOFF GLADHAND

- Flange mount
- Metal handle shutoff
- Full face rubber seal
- Tough metal Ball valve
- Color coded
- Meets SAE J318

PART #	DESCRIPTION	MATERIAL	SEAL	FILTER	PORT A NPT	PORT B NPT
39531	Emergency (Red)	Aluminum	Blk Rubber	No	3/8"	1/4" ----
39530	Service (Blue)	Aluminum	Blk Rubber	No	3/8"	1/4" ----

WARNING: This product can expose you to chemicals, including lead, which are known to the State of California to cause cancer and birth defects or other reproductive harm. For more information, visit www.P65Warnings.ca.gov

TRUCK & TRAILER

AIR
TRUCK AND TRAILER

GLADHAND GRIPS



1/2" NPTF.

- Comes with hardware and sealant
- Color-coded red and blue for easy air line identification - clamshell
- Handles are heat, oil and UV-resistant.
- Meet SAE J318

PART #	DESCRIPTION	
39535	Poly grip hardware	----

ALUMINUM GLADHAND GRIPS



- 1/2" NPTF
- Each pack contains (1) red and (1) blue - clamshell
- One piece design
- No screws or plastic parts
- Easy to install
- Class II anodized coating provides greater corrosion resistance

PART #	DESCRIPTION	
39537	Sure grip	----

GLADHAND PACIFIER SEAL



- Seals Gladhand from moisture, dirt and debris

PART #	DESCRIPTION	
39566	Gladhand pacifier	----

GLADHAND SEALS

Seal Options:

- Rubber
- Polyurethane
- With screen filter
- Double lip
- Filter screen only



PART #	DESCRIPTION	
39541	Blue, Polyurethane	----
39542	Red, Polyurethane	----
39543	Black, Polyurethane	----
39556	Blue with a screen filter Polyurethane	----
39557	Red with a screen filter Polyurethane	----
39558	Black with a screen filter Polyurethane	----
39550	Blue Double lip, Polyurethane	----
39551	Red Double Lips, Polyurethane	----
39552	Double Lip, Polyurethane	----
39544	Grey, Closed Style, Polyurethane	----
39560	Filter, Screen, Gladhand	----
39559	Filter, Screen, Gladhand	----

WARNING: This product can expose you to chemicals, including lead, which are known to the State of California to cause cancer and birth defects or other reproductive harm. For more information, visit www.P65Warnings.ca.gov

AIR

TRUCK AND TRAILER



39565

DUMMY GLADHAND COUPLING KIT

- 6 1/2" coupling length

PART #	CONNECTION	VENT	MATERIAL	
39563	Chain	Yes	Steel Yellow Zinc plated	----
39564	Chain	No	Steel Yellow Zinc plated	----
39565	Cable	N/A	Aluminum	----

NYLON GLADHAND AND PLUG HOLDER

- Stores Gladhand and electrical hook ups at a 45° angle.
- Can accept heavy ABS plug
- Standard mounting holes to install on back of cab.
- Glass-filled nylon, non-corrosive construction.



39574

39575

PART #	DESCRIPTION	
39574	1 plug slot	----
39575	2 plug slot	----

GLADHAND HOLDER KIT

- Steel - Zinc Yellow Dichromate
- Holds gladhands when disconnected



PART #	DESCRIPTION	
39573	Holder Kit	----
39572	Bracket only	----

GLADHAND LOCK

- Red molded plastic
- Prevents unwanted connections with trailers
- Protects idle units
- Universal for Aluminum and Iron Gladhands
- Supplied with 2-keys



PART #	DESCRIPTION	
39570	Gladhand Lock w/ 2 keys	----

*** Not an Anti theft device**

KING PIN LOCK-ANTI HOOK UP

- Cast, Zinc plated
- Anti-tractor, trailer hook-up
- Supplied with 2 keys



PART #	DESCRIPTION	
39860	King Pin Lock w/ 2 keys	----

WARNING: This product can expose you to chemicals, including lead, which are known to the State of California to cause cancer and birth defects or other reproductive harm. For more information, visit www.P65Warnings.ca.gov

TRUCK & TRAILER

AIR CYLINDER



- 300 series stainless steel cylinder shafts provide excellent corrosion resistance and extended cycle life -cylinders tested to over 500,000 cycles.
- Lightweight, corrosion resistant aluminum tube with die cast aluminum end caps.
- Rear clevis cast as integral part of the rear cover for improved durability and mounting integrity.
- Double acting, Emralon-coated piston cup assures smooth long lasting operation even in cold weather conditions to (- 40°F).
- Front end cap assembly includes pressure seal, dirt seal and oil impregnated bronze bushing.
- Cylinder tube imprinted with part number and date code for quick identification.
- All cylinders are factory pressure and leak tested prior to shipping.
- Front Cover Kit-Includes front cover with bushing and seals installed and two cylinder gaskets.
- Rear Cover Kit-Includes rear cover with two cylinder gaskets.
- Piston Cup Kit-Includes piston cup, lock nut and two cylinder gaskets.
- Shaft Kit-Includes shaft, lock nut and two cylinder gaskets.

PART #	SIZE	STROKE	RETRACTED	EXTENDED	TYPE	
39672	2 1/2"	4.0"	9.89"	13.89"	push/pull	----
39673	2 1/2"	6.0"	11.89"	17.89"	push/pull	----
39674	2 1/2"	8.0"	13.89"	21.89"	push/pull	----
39675	2 1/2"	6.0"	13.75"	19.75"	Spring return	----
39676	3 1/2"	8.0"	15.60"	24.28"	push/pull	----
39677	3 1/2"	10.0"	16.92"	26.95"	push/pull	----



HIGH LIFT AIR CYLINDERS

- Aluminum tube with 16 RMS finish
- Temp rating -40 to 185°F
- Recommended working pressure 150 psi
- Minimum bursting pressure 150 psi
- 1275 lb. thrust at 100 psi
- 1158 lb. draw at 100 psi

PART #	DIA.	STROKE	RETRACTED	EXTENDED	TYPE	
39654	4"	24"	34.5"	58.5"	push/pull	----

WARNING: This product can expose you to chemicals, including lead, which are known to the State of California to cause cancer and birth defects or other reproductive harm. For more information, visit www.P65Warnings.ca.gov

TAILGATE AIR CYLINDERS

- Die cast aluminum with mount hole for 1/2" pin and 1/4" NPT port
- Molded piston cup
- Stainless steel piston rod with 5/8" – 18 thread
- 10 PSI – 120 PSI
- 10 psi min-120 psi max



PART #	DIA.	STROKE	LENGTH	TYPE	
39655	2-1/2"	4.0"	13.37	Push/Pull	----
39656	2-1/2"	6.0"	17.37	Push/Pull	----
39657	2-1/2"	8.0"	21.37	Push/Pull	----
39658	2-1/2"	4.0"	14.71	Spring Ret	----
39659	2-1/2"	6.0"	19.75	Spring Ret	----
39660	3-1/2"	6.0"	20.23	Push/Pull	----
39661	3-1/2"	8.0"	24.23	Push/Pull	----
39662	3-1/2"	8.0"	26.98	Push/Pull	----
39663	3-1/2"	10.0"	28.98	Push/Pull	----



TAILGATE AIR CYLINDERS

- Machined aluminum, 5/8" diameter ,stainless steel shaft with 5/8" - 18 threads, "O" rings and a UHMW polyethylene wear band
- Direct replacements to Haldex and MGM
- Standard operating pressure 100 psi
- 90psi min to 150 psi max

PART #	DIA.	STROKE	BRACKET	TYPE	
39665	6"	3"	Yes	Spring Ret	----
39667	6"	4.38"	No	Spring Ret	----



FIFTH WHEEL AIR CYLINDER

- 1/4" FPT port cast aluminum front and rear
- 2-1/2" Bore
- 6-3/4" stroke
- Front and rear mounting hole for 17/32" clevis,
- 100 psi
- Gold anodized tube for corrosion resistance

PART #	DESCRIPTION	
39669	Fifth Wheel Air Cylinder	----

WARNING: This product can expose you to chemicals, including lead, which are known to the State of California to cause cancer and birth defects or other reproductive harm. For more information, visit www.P65Warnings.ca.gov

AIR TANK DRAIN PULL VALVE



PART #	SIZE	DESCRIPTION	
39595	1/4" male	5ft nylon coated pull cable	----
39596	1/4" male	4ft nylon coated pull cable	----
39597	1/4" male	3ft nylon coated pull cable	----
39600	1/4" male	Air valve only	----

AIR TANK CHECK VALVE

- Single check valves allow air to pass from a single source to its destination, and prevent air travel in the opposite direction.



PART #	MALE X FEMALE	
39604	1/4"	----
39605	3/8"	----
39606	1/2"	----

D-2 STYLE AIR BRAKE GOVERNOR

- Opening and closing pressures of 100 to 120 psi
- High temperature O-ring construction
- Gasket and plugs included
- Replaces Bendix 275491 & Midland KN18530



PART #	THREAD	DESCRIPTION	
39592	6-1/8" NPT	Air Brake Governors D-2 style	----

IN-LINE QUICK RELEASE VALVE

- Quick release for the air brake system
- 3/8" female exhaust port
- 2-3/8" female delivery port
- Cracking pressure: 1 PSI
- Helps meet the FMVSS -121 requirement for timing



PART #	DESCRIPTION	
39610*	3/8" NPT In-Line quick release valve	----
39611**	1/2" NPT In-Line quick release valve	----

* Replaces Bendix 229859, 288351 & Midland KN32005

** Replaces Bendix 229860 & Midland KN32011

R-12 RELAY VALVE

- 1/4" Relay Valve with multiple delivery ports
- Replaces Bendix 102166, 102626, 103009



PART #	SUPPLY PORT	DELIVERY PORT	DESCRIPTION	
39613	1/2" NPT	4, 1/2"NPT	4 psi no Bracket	----
39614	1/2" NPT	4, 1/2"NPT	4 psi Relay Valve	----
39615	3/4" NPT	2, 1/2" NPT	4 psi Relay Valve	----

WARNING: This product can expose you to chemicals, including lead, which are known to the State of California to cause cancer and birth defects or other reproductive harm. For more information, visit www.P65Warnings.ca.gov

AIR

TRUCK AND TRAILER



R-14 RELAY VALVE

- 1/4" Relay Valve with two delivery and supply ports
- Replaces Bendix 103010

PART #	SUPPLY PORT	DELIVERY PORT	DESCRIPTION	
39616	2-3/4"NPT	2-1/2"NPT	4 psi Relay Valve	----



THREE WAY SOLENOID

- Operates a minimum GF 50,000 cycles
- Inlet port normally closed
- Must be mounted vertically with the air inlet port facing up
- 1/4" female NPT ports
- 12 Volts
- 100-120 psi operating pressure
- Attached mounting bracket with two 9/32" diameter mounting holes on 2-1/2" centers

PART #	SUPPLY PORT	DESCRIPTION	
39684	2, 1/4" FPT	Three way Solenoid	----



UNIVERSAL SOLENOID

- Operates a minimum of 50,000 cycles.
- 125 amps at 12 volts.
- Continuous voltage.
- One on/off circuit
- 5/16 inch side studs, No. 10 top stud(s).
- 2 1/8 on Center
- 5/16 x 19/32
- Hardware included.
- Normally open

PART #	DESCRIPTION	
39687	4 stud Solenoid	---
39688	3 stud Solenoid	---



AIR SOLENOID VALVE

- Operates a minimum of 50,000 cycles.
- 100 psi max pressure.
- 1/4" Thread
- 10 Watts, 12 VDC
- Replaces Neway 90054075

PART #	DESCRIPTION	
39689	12V Closed	---
39690	12V Open	---

WARNING: This product can expose you to chemicals, including lead, which are known to the State of California to cause cancer and birth defects or other reproductive harm. For more information, visit www.P65Warnings.ca.gov

TRUCK & TRAILER

COILED CABLE

SEVEN-WAY COILED CABLE ASSEMBLIES



- ABS assemblies are heavy duty to power trailers
- HD Green gives clear ABS identification
- Resists abrasion, great coil retention
- Heavy duty plugs with spring guards
- ABS Cable meets SAE J2394
- Operating temperature range of -55° to +185°F

PIN LOCATION	COLOR CODE	GAUGE	CIRCUIT
1	White	8	Ground
2	Black	12	Clearance, side and ID lamps
3	Yellow	12	Left turn and Hazard
4	Red	10	Stop lamp and Anti-lock
5	Green	12	Right turn and Hazard
6	Brown	12	Tail and Plate lamp

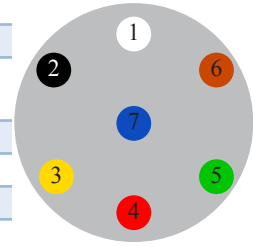

ABS

PART #	LENGTH	DESCRIPTION	
39736	12'	Coiled Electrical Cord, ABS w/12 in lead, w/plugs, Green	----
39737	15'	Coiled Electrical Cord, ABS w/12 in lead, w/plugs, Green	----

SEVEN-WAY COILED CABLE BLACK

- This high quality, durable construction is recommended for single-trailer configurations using standard lighting on non-ABS vehicles.
- Durable black outer jacket with heavy duty zinc die cast plugs and two spring guards included.



PIN	COLOR CODE	HD GAUGE	ECO GAUGE	CIRCUIT
1	White	10	12	Ground
2	Black	12	14	Clearance, side and ID lamps
3	Yellow	12	14	Left turn and Hazard
4	Red	12	14	Stop lamp and Anti-lock
5	Green	12	14	Right turn and Hazard
6	Brown	12	14	Tail and Plate lamp
7	Blue	12	14	ABS Power Aux

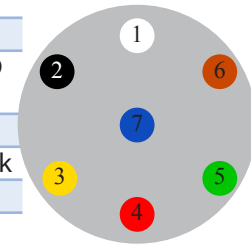

STANDARD - HEAVY DUTY

PART #	LENGTH	DESCRIPTION	
39738	12'	Coiled Electrical Cord, w/12 in lead, w/plugs, Black	----
39739	15'	Coiled Electrical Cord, w/15 in lead, w/plugs, Black	----

STANDARD - ECONOMY

PART #	LENGTH	DESCRIPTION	
39740	12'	Coiled Electrical Cord, w/12 in lead, w/plugs, Black	----
39741	15'	Coiled Electrical Cord, w/12 in lead, w/plugs, Black	----

WARNING: This product can expose you to chemicals, including lead, which are known to the State of California to cause cancer and birth defects or other reproductive harm. For more information, visit www.P65Warnings.ca.gov

SIX WAY COILED ELECTRIC CABLE ASSEMBLY



- 6', 8', 12' Length
- Includes 2 Thermoseal 6-way plugs
- For light duty towing applications such as boats and utility trailers
- Plugs are molded for moisture and corrosion resistance
- 4/14 Gauge cable
- Flexible from -55°F to 150°F (-66°C to 66°C)

PART #	DESCRIPTION	
39752	6ft, 14awg w/12" Lead at 2 ends	----
39753	8 ft, 14awg w/12" Lead at 2 ends	----
39754	12ft,14awg w/12" Lead at 2 ends	----

FOUR WAY COILED ELECTRIC CABLE ASSEMBLY



- 4/14 Gauge cable
- 12' & 15' length
- Includes 2 Thermoseal 4-way plugs
- For light duty towing applications such as boats and utility trailers
- Plugs are molded for moisture and corrosion resistance
- Flexible from -55°F to 150°F (-66°C to 66°C)

PART #	DESCRIPTION	
39748	12' with 12" Lead, both ends 4/14awg	----
39749	15' with 12" Lead, both ends 4/14awg	----

DUEL POLE COILED ELECTRIC CABLE ASSEMBLY



- Black Jacket
- 12' & 15' length
- 200 Amp at 12 VDC.
- Zinc die cast plugs.
- 4 gauge cable.

PART #	DESCRIPTION	
39744	12' Coil With 12" Lead at 2 ends 4awg	----
39745	15' Coil With 12" Lead at 2 ends 4awg	----

SINGLE POLE COILED ELECTRIC CABLE ASSEMBLY



- Black Jacket
- 12' & 15' length
- For applications that require direct electrical power to trailer lift gates.
- Rated at 265 amps on/off service (30 seconds on/50 seconds off).
- Zinc die cast plugs with spring guards included.
- 4 gauge cable.

PART #	DESCRIPTION	
39742	12' Coil With 12" Lead both ends 4awg	----
39743	15' Coil With 12" Lead both ends 4awg	----

WARNING: This product can expose you to chemicals, including lead, which are known to the State of California to cause cancer and birth defects or other reproductive harm. For more information, visit www.P65Warnings.ca.gov

ELECTRICAL

TRUCK AND TRAILER

7 WAY PLUGS AND SOCKETS

- Heavy-duty, nickel-plated zinc die cast housings
- Brass terminal pins for maximum current carrying ability
- Field repairable with standard tools
- Fully interchangeable with other SAE-type, 7-way connectors
- ATA marked wire terminals.
- Internal clamp holds cable securely in place.
- Standard seven-way plugs meet ATA and SAE J560 requirements
- ISO plugs meet ISO 3731:1997 requirements.
- ISO socket prevents connections with Non-ISO plugs - Used in tractor/trailer systems
- ISO color-coded yellow, non-corrosive reinforced nylon housing.



39758



39757



39772



PLUGS

PART #	DESCRIPTION	
39757	7-Way Single Grip Plug w/Spring Guard	----
39758	7-Way Single Grip Plug NO Spring.	----
39772	7-Way Double Grip Plug w/Spring.	----
39773	7-Way Double Grip Plug NO Spring Guard	----
39788	7-way ISO plug	----

SOCKETS

PART #	DESCRIPTION	
39774	Solid Pin 7-Way Metal Socket	----
39775	Split Pin 7-Way Metal Socket	----
39789	7-way, ISO socket	----

7 WAY DOUBLE GRIP PLUG

- T-Grip weather guard
- Plastic grip

PART #	DESCRIPTION	
39818	7-Way Double Grip Plug, Plastic	----

6 AND 7 WAY ADAPTER

PART #	DESCRIPTION	
39786	Seven way plug to Six Way Socket Adapter	----
39787	Six way plug to Seven Way socket Adapter	----

RV 7-WAY PLUG

- Primarily used in RV applications.
- Constructed of molded PVC for impact resistance
- Blade Style Pin

PART #	DESCRIPTION	
39819	7-way Plastic plug	----

RV 7-WAY SOCKET

- RV Screw-type socket
- 6-24 VDC.
- Mounting 2-1/4" inch on center .
- Constructed of molded PVC

PART #	DESCRIPTION	
39820	7-way socket	----

WARNING: This product can expose you to chemicals, including lead, which are known to the State of California to cause cancer and birth defects or other reproductive harm. For more information, visit www.P65Warnings.ca.gov

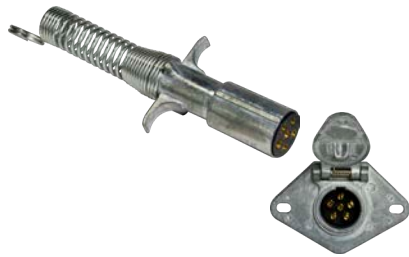

6 - WAY PLUGS AND SOCKETS

PART #	DESCRIPTION	
39782	6-Way Double Grip Metal Plug w/Spring Guard.	----
39783	6-Way Metal Socket.	----

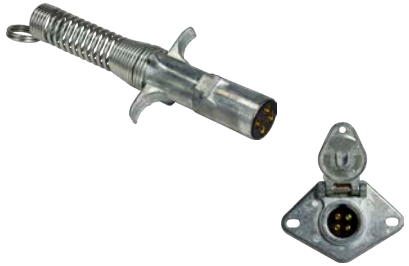

4 WAY PLUGS AND SOCKETS

- Heavy-duty zinc die cast housings on plugs and sockets.
- Plug locking system works with socket door to ensure proper hookup and prevent unintentional disconnections.
- Spring guard supports and protects cable.

4 - WAY

PART #	DESCRIPTION	
39778	4-Way Double Grip Metal Plug w/Spring Guard.	----
39779	4-Way Metal Socket.	----



2 POLE PLUGS AND SOCKETS

- 200 amp 4 gauge wire capacity.
- Heavy-duty zinc die cast housing.
- Internal ground.
- Spring guard supports and protects cable.

PART #	DESCRIPTION	
39768	2 Pole Double Grip Metal Plug w/Spring Guard.	----
39769	2 Pole Metal Socket	----



SINGLE POLE PLUGS AND SOCKETS

- Used to provide power to heavy draw auxiliary trailer equipment.
- Heavy-duty zinc die cast housings.
- Power and ground terminals hold up to 1/0 gauge wire.

PART #	DESCRIPTION	
39764	1-Way Double Grip Plug w/Spring Guard.	----
39765	1-Way Double Grip Plug w/Spring Guard and Ground Kit	----
39766	1-Way Metal Socket	----



GROUND KIT

PART #	DESCRIPTION	
39809	Ground Kit (Bolt, Nut and Wire Lug) for 1-Way Plug or Socket	----



PROTECTOR BOOT FOR PLUG

- Protective rubber boot seals out moisture and contaminants

PART #	DESCRIPTION	
39807	Protector Boot	----

WARNING: This product can expose you to chemicals, including lead, which are known to the State of California to cause cancer and birth defects or other reproductive harm. For more information, visit www.P65Warnings.ca.gov

ELECTRICAL

TRUCK AND TRAILER

7 WAY SOCKET WITH CIRCUIT BREAKER



- Non-corrosive, reinforced nylon housing for added durability.
- Designed for No. 8 ring terminals.
- ATA color-coded contacts.
- Solid brass split pins are zinc-plated for corrosion resistance.
- Each socket includes automatic reset circuit breakers with positive snap action to eliminate arcing (unless otherwise noted).
- Mounting holes are 4 1/2 inch on center and include steel bushings for added housing protection.
- Adhesive-backed mounting gasket included.
- Circuit breaker sockets meet SAE J560 requirements.

PART #	DESCRIPTION	
39792	No circuit breakers	----
39793	15amp Plastic with circuit breakers	----
39794	20amp Plastic with circuit breakers	----
39795	30amp Plastic with circuit breakers	----



7 WAY CIRCUIT CHASER

- Instantly finds short or faulty circuits
- Portable

PART #	DESCRIPTION	
39805	7 way circuit	----

CIRCUIT BREAKERS - PLASTIC

- Colored Battery molded Stud
- 12 Volt
- Meets SAE j553 requirements
- Nuts included



PART #	DESCRIPTION	
39800	15 AMP	----
39801	20 AMP	----
39802	25 AMP	----
39803	30 AMP	----

NOSE BOX - DEEP

- Zinc - extra deep



PART #	DESCRIPTION	
39814	Deep Nose Box	----

WARNING: This product can expose you to chemicals, including lead, which are known to the State of California to cause cancer and birth defects or other reproductive harm. For more information, visit www.P65Warnings.ca.gov

BATTERY GROUND STRAP



- 4 gauge wire.
- Molded zinc-plated steel lugs and tin-plated copper stranding.
- 7/16 inch diameter bolt hole.
- 12" Long

PART #	DESCRIPTION	
39712	12", 4 Gauge ground strap	----

STAINLESS STEEL BATTERY NUT



PART #	TYPE	
39713	3/8"	----

RUBBER GROMMET

- Black Rubber



PART #	ID	OD	
95450	5/16"	9/16"	----
95451	5/8"	1 1/4"	----
95452	3/4"	1 3/4"	----

WARNING: This product can expose you to chemicals, including lead, which are known to the State of California to cause cancer and birth defects or other reproductive harm. For more information, visit www.P65Warnings.ca.gov

TRUCK & TRAILER

ACCESSORIES

TRUCK AND TRAILER

ACCESSORIES**DEER WHISTLES**

- Produces two separate and unique frequencies
- High output airflow activated
- Can be removed from base for cleaning and car washes
- Mounts with high bond tape **(included)**
- Lowers risk for vehicle-animal collisions

PART #	DESCRIPTION	
39465	2 pack whistle	----

CABLE TIE STRAPS - NYLON

- Used to secure and bundle
- CSA Certified
- RoHs Compliant
- UV or Standard

**STANDARD**

PART #	LENGTH	STRENGTH	PACKAGE QTY	
95601	7 1/2"	50lb	100	----
95602	11"	50 lb	100	----
95603	14.5"	50 lb	100	----
95604	24"	175 lb	50	----
95605	36"	175lb	50	----
95606	48"	175 lb	50	----

UV BLACK

PART #	LENGTH	STRENGTH	PACKAGE QTY	
95610	7 1/2"	50lb	100	----
95611	14"	50 lb	100	----
95612	24"	175lb	50	----
95613	36"	175lb	50	----

WARNING: This product can expose you to chemicals, including lead, which are known to the State of California to cause cancer and birth defects or other reproductive harm. For more information, visit www.P65Warnings.ca.gov

ACCESSORIES

TRUCK AND TRAILER

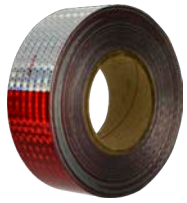

95620

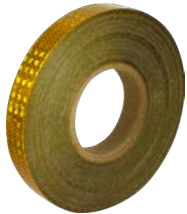
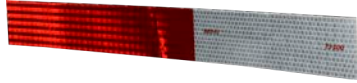

95625



95627



95628



CONSPICUITY TAPE

Tape is designed for trucks, trailers, and other vehicles for easy nighttime vehicle recognition and increased road safety. It is a high quality, durable microprismatic retroreflective material with a pressure sensitive adhesive. The solid construction does not require edge sealing. Conspicuity tape provides superior reflectivity and may help reduce accidents.

- DOT -C2 Certified
- Meets or exceeds NHTSA, FMVSS 108 & ASTM D4956
- Meets Canada TSD 108
- 10 year durability

PART #	DESCRIPTION	APP. WT.	
95620	2" x 150' Roll of 11" Red / 7" White	0.32	----
95621	2" x 150' Roll of 6" Red / 6" White	0.32	----
95622	2" x 150' Roll of solid white	0.32	----
95623	2" x 18", kiss cut strip, white	0.03	----
95624	2" x 18" kiss cut strip of 11" Red / 7" White	0.03	----

- Meets or exceeds ANSI/SAE S279, ANSI/SAE S276 & ASTM D-4956
- 7 year durability

PART #	DESCRIPTION	APP. WT.	
95625	1" X 150' Roll of solid yellow	0.17	----
95626	2" X 150' Roll of solid yellow	0.32	----
95627	3" round all plastic reflector, Red	0.06	----
95628	3 3/4" x 6 1/2" American flag, type IV HIP	0.02	----

TARP STRAPS

- Heavy Duty EPDM tarp straps
- Longer lasting than rubber
- Greater stretch length
- Ozone and weather resilient
- Made in the USA

PART #	STRAP LENGTH	MATERIAL	DESCRIPTION	QTY	
990790	10"	EPDM	Tarp strap with S hook	50	----
990791	15"	EPDM	Tarp strap with S hook	50	----
990792	21"	EPDM	Tarp strap with S hook	50	----
990793	31"	EPDM	Tarp strap with S hook	50	----
990794	41"	EPDM	Tarp strap with S hook	50	----

WARNING: This product can expose you to chemicals, including lead, which are known to the State of California to cause cancer and birth defects or other reproductive harm. For more information, visit www.P65Warnings.ca.gov

NYLON DOT AIR BRAKE TUBING

TRUCK AND TRAILER



- Air Brake Tubing available from inventory in a large variety of colors and sizes
- Superior cold weather flexibility and abrasion resistance
- UV and ozone resistant nylon
- Meets or exceeds SAEJ844 (Type A - non-reinforced & Type B - reinforced)
- Meets or exceeds DOT requirements for use with compression fittings (NOTE: SAE does not recognize 1/8", 5/32" or 3/16" O.D. tubing for use with air brake systems)
- Air Brake Tubing identified per SAE J844 & FMVSS No. 106 Brake Hoses, 49 CFR 571.106
- Conforms to our own rigorous qualification and inspection testing which exceeds SAE and DOT requirements
- Designed to operate at up to 150 psi in air brake systems
- Resistant to attack by gasoline, diesel fuel and commonly used road and cleaning chemicals
- Air Brake Tubing available on bulk spools or by packages
- Operating range: -40° - 200°F - Not made for fuel

PART NUMBER	COLOR	LENGTH	NOMINAL O.D.	NOMINAL WALL	
38950B2	Black	2000'	1/8"	0.023"	----
38950	Black	100'	1/8"	0.023"	----
3895BA	Black	50'	1/8"	0.023"	----
38951B1	Black	1000'	5/32"	0.032"	----
38951	Black	100'	5/32"	0.032"	----
38951BA	Black	50'	5/32"	0.032"	----
38953B1	Black	1000'	3/16"	0.035"	----
38953	Black	100'	3/16"	0.035"	----
38953BA	Black	50'	3/16"	0.035"	----
389523	Black	1000'	1/4"	0.040"	----
389522	Black	500'	1/4"	0.040"	----
38952	Black	100'	1/4"	0.040"	----
38952BA	Black	50'	1/4"	0.040"	----
38952U1	Blue	1000'	1/4"	0.040"	----
38952U	Blue	100'	1/4"	0.040"	----
38952UA	Blue	50'	1/4"	0.040"	----
38952O	Orange	100'	1/4"	0.040"	----
38952OA	Orange	50'	1/4"	0.040"	----
38952G1	Green	1000'	1/4"	0.040"	----
38952G	Green	100'	1/4"	0.040"	----
38952GA	Green	50'	1/4"	0.040"	----
38952R1	Red	1000'	1/4"	0.040"	----
38952R	Red	100'	1/4"	0.040"	----
38952RA	Red	50'	1/4"	0.040"	----
38952Y1	Yellow	1000'	1/4"	0.040"	----
38952Y	Yellow	100'	1/4"	0.040"	----
38952YA	Yellow	50'	1/4"	0.040"	----
38954B5	Black	500'	5/16"	0.040"	----
38954	Black	100'	5/16"	0.040"	----
38954BA	Black	50'	5/16"	0.040"	----
38960B5	Black	500'	3/8"	0.062"	----
38960	Black	100'	3/8"	0.062"	----
38960BA	Black	50'	3/8"	0.062"	----
38960U5	Blue	500'	3/8"	0.062"	----
38960U	Blue	100'	3/8"	0.062"	----
38960UA	Blue	50'	3/8"	0.062"	----
38960O5	Orange	500'	3/8"	0.062"	----
38960O	Orange	100'	3/8"	0.062"	----
38960OA	Orange	50'	3/8"	0.062"	----
38960G5	Green	500'	3/8"	0.062"	----
38960G	Green	100'	3/8"	0.062"	----
38960GA	Green	50'	3/8"	0.062"	----
38960R5	Red	500'	3/8"	0.062"	----
38960R	Red	100'	3/8"	0.062"	----

PART NUMBER	COLOR	LENGTH	NOMINAL O.D.	NOMINAL WALL	
38960RA	Red	50'	3/8"	0.062"	----
38960Y5	Yellow	500'	3/8"	0.062"	----
38960Y	Yellow	100'	3/8"	0.062"	----
38960YA	Yellow	50'	3/8"	0.062"	----
38965B5	Black	500'	1/2"	0.062"	----
38965	Black	100'	1/2"	0.062"	----
38965BA	Black	50'	1/2"	0.062"	----
38965U5	Blue	500'	1/2"	0.062"	----
38965U	Blue	100'	1/2"	0.062"	----
38965UA	Blue	50'	1/2"	0.062"	----
38965O5	Orange	500'	1/2"	0.062"	----
38965O	Orange	100'	1/2"	0.062"	----
38965OA	Orange	50'	1/2"	0.062"	----
38965G5	Green	500'	1/2"	0.062"	----
38965G	Green	100'	1/2"	0.062"	----
38965GA	Green	50'	1/2"	0.062"	----
38965R5	Red	500'	1/2"	0.062"	----
38965R	Red	100'	1/2"	0.062"	----
38965RA	Red	50'	1/2"	0.062"	----
38965Y5	Yellow	500'	1/2"	0.062"	----
38965Y	Yellow	100'	1/2"	0.062"	----
38965YA	Yellow	50'	1/2"	0.062"	----
38970BC	Black	250'	5/8"	0.092"	----
38970	Black	100'	5/8"	0.092"	----
38970BA	Black	50'	5/8"	0.092"	----
38970GC	Green	250'	5/8"	0.092"	----
38970G	Green	100'	5/8"	0.092"	----
38970GA	Green	50'	5/8"	0.092"	----
38970RC	Red	250'	5/8"	0.092"	----
38970R	Red	100'	5/8"	0.092"	----
38970RA	Red	50'	5/8"	0.092"	----
38975BC	Black	250'	3/4"	0.092"	----
38975	Black	100'	3/4"	0.092"	----
38975BA	Black	50'	3/4"	0.092"	----
38975GC	Green	250'	3/4"	0.092"	----
38975G	Green	100'	3/4"	0.092"	----
38975GA	Green	50'	3/4"	0.092"	----

WARNING: This product can expose you to chemicals, including lead, which are known to the State of California to cause cancer and birth defects or other reproductive harm. For more information, visit www.P65Warnings.ca.gov

FUEL LINE AND AIR BRAKE HOSE

TRUCK AND TRAILER

FUEL LINE AND VAPOR EMISSION

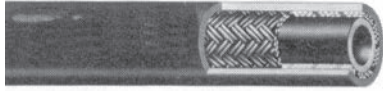

- SAE 30R7
- Nitrile tube w/ spiral synthetic cord, hypalon cover.
- 50 p.s.i. working pressure. 1/2 -35 PSI
- -40° F to + 257° F temperature range.
- Low pressure/ high temperature fuel for cars, light trucks, and small engines.
- Meets SAE J1402

PART #	ID	OD	LENGTH	
38920	3/16	13/32	25'	----
38926	5/16	9/16	25'	----
38923	1/4	1/2	25'	----
38927	3/8	5/8	50'	----

AIR BRAKE HOSE



- BLACK

- Spiral synthetic cord reinforcement with neoprene cover.
- -40° F to +200° F temperature range.
- Max operating pressure 255 psi
- Max burst pressure 900 psi
- Meets SAE J1402

PART #	ID	OD	LENGTH	
38910	3/8	3/4	50'	----
38915	1/2	7/8	50'	----

WARNING: This product can expose you to chemicals, including lead, which are known to the State of California to cause cancer and birth defects or other reproductive harm. For more information, visit www.P65Warnings.ca.gov

300 & 600 WORM GEAR CLAMPS

TRUCK AND TRAILER

WORM GEAR CLAMPS**MINIATURE CLAMPS - 5/16" BAND**

Stainless Steel band with Carbon Steel Housing and Screw

300 Series

- 1/4" Hex Slotted Carbon Steel Screw
- 5/16" Wide 301 Stainless Steel Band
- Carbon Steel Housing

Applications: For marine, agricultural, industrial and automotive uses. Corrosion resistance varies with stainless components.

Mechanically interlocked, 3 piece construction for service sealing pressure without spot welding.

5/16" band, 1/4" screw

PART #	DIA. RANGE		BOX/CASE	
	MIN.	MAX.		
3000004	7/32"	5/8"	200/2400	----
3000005	7/16"	11/16"	200/2400	----
3000006	5/16"	7/8"	200/2400	----
3000008	7/16"	1"	200/1200	----
3000010	1/2"	1-1/16"	200/1200	----
3000012	9/16"	1-1/4"	200/1200	----
3000016	11/16"	1-1/2"	200/1200	----
3000020	7/8"	1-3/4"	200/1200	----

1/2" BAND CLAMPS

Stainless Steel band with Carbon Steel Housing and Screw

1/2" band, 5/16" screw

600 Series

- 5/16" Hex Slotted Carbon Steel Screw
- 1/2" Wide 201 Stainless Steel Band
- Carbon Steel Housing

Applications: A general purpose clamp for automobiles, plumbing, home and garden general clamping applications, with anti-corrosive properties varying with the number of components made from stainless steel.

- No PSI Rating
- 50lb/ Inch Torque Rating Die Set Function

PART #	#	DIA. RANGE		BAG/CASE	
		MIN.	MAX.		
600006	6	3/8"	7/8"	100/600	----
600008	8	7/16"	1"	100/600	----
600010	10	9/16"	1-1/16"	100/600	----
600012	12	9/16"	1-1/4"	100/600	----
600016	16	11/16"	1-1/2"	100/600	----
600020	20	3/4"	1-3/4"	100/300	----
600024	24	1-1/16"	2"	100/300	----
600028	28	1-5/16"	2-1/4"	100/300	----
600032	32	1-9/16"	2-1/2"	100/300	----
600036	36	1-13/16"	2-3/4"	50/200	----
600040	40	2-1/16"	3"	50/200	----
600044	44	2-5/16"	3-1/4"	50/200	----
600048	48	2-9/16"	3-1/2"	50/200	----
600052	52	2-13/16"	3-3/4"	25/100	----
600056	56	3-1/16"	4"	25/100	----
600060	60	3-5/16"	4-1/4"	25/100	----
600064	64	2-1/2"	4-1/2"	25/100	----
600072	72	3"	5"	25/100	----
600080	80	3-1/2"	5-1/2"	10/100	----
600088	88	4"	6"	10/100	----
600096	96	4-1/2"	6-1/2"	10/100	----
600104	104	5"	7"	10/100	----

WARNING: This product can expose you to chemicals, including lead, which are known to the State of California to cause cancer and birth defects or other reproductive harm. For more information, visit www.P65Warnings.ca.gov



325 & 611 WORM GEAR CLAMPS

TRUCK AND TRAILER

MINIATURE CLAMPS - 5/16" BAND



325 Series

- 1/4" Hex Slotted Carbon Steel Screw
- 5/16" Wide 301 Stainless Steel Band
- 301 Stainless Steel Housing

Applications: For agricultural, industrial and automotive uses. Corrosion resistance varies with stainless components.

Mechanically interlocked, 3 piece construction for service sealing pressure without spot welding.

Stainless Steel band and housing with Carbon Steel Screw

5/16" band, 1/4" screw

PART #	DIA. RANGE		BOX/CASE	
	MIN.	MAX.		
325004	7/32"	5/8"	200/2400	----
325005	7/16"	11/16"	200/2400	----
325006	5/16"	7/8"	200/2400	----
325008	7/16"	1"	200/1200	----
325010	1/2"	1-1/16"	200/1200	----
325012	9/16"	1-1/4"	200/1200	----
325016	11/16"	1-1/2"	200/1200	----
325020	7/8"	1-3/4"	200/1200	----

1/2" BAND CLAMPS



611 Series

- 5/16" Hex Slotted Carbon Steel Screw
- 1/2" Wide 201 Stainless Steel Band
- 301 Stainless Steel Housing

Applications: The perfect clamp for automobiles, plumbing, home and garden general clamping applications, with anti-corrosive properties varying with the number of components made from stainless steel.

- No PSI Rating
- 50lb/ Inch Torque Rating Die Set Function

Stainless Steel band and housing with Carbon Steel Screw

1/2" band, 5/16" screw

PART #	#	DIA. RANGE		BAG/CASE	
		MIN.	MAX.		
611006	6	3/8"	7/8"	100/600	----
611008	8	7/16"	1"	100/600	----
611010	10	9/16"	1-1/16"	100/600	----
611012	12	9/16"	1-1/4"	100/600	----
611016	16	11/16"	1-1/2"	100/600	----
611020	20	3/4"	1-3/4"	100/300	----
611024	24	1-1/16"	2"	100/300	----
611028	28	1-5/16"	2-1/4"	100/300	----
611032	32	1-9/16"	2-1/2"	100/300	----
611036	36	1-13/16"	2-3/4"	50/200	----
611040	40	2-1/16"	3"	50/200	----
611044	44	2-5/16"	3-1/4"	50/200	----
611048	48	2-9/16"	3-1/2"	50/200	----
611052	52	2-13/16"	3-3/4"	25/100	----
611056	56	3-1/16"	4"	25/100	----
611060	60	3-5/16"	4-1/4"	25/100	----
611064	64	2-1/2"	4-1/2"	25/100	----
611072	72	3"	5"	25/100	----
611080	80	3-1/2"	5-1/2"	10/100	----
611088	88	4"	6"	10/100	----
611096	96	4-1/2"	6-1/2"	10/100	----
611104	104	5"	7"	10/100	----
611116	116	5-3/4"	7-3/4"	100/100	----
611128	128	6-1/2"	8-1/2"	100/100	----
611152	152	2"	10"	100/100	----
611164	164	1-3/4"	10-3/4"	100/100	----
611176	176	9-1/4"	11-1/4"	100/100	----
611188	188	2-1/16"	12-1/4"	100/100	----
611200	200	11"	13"	100/100	----
611212	212	11-3/4"	13-3/4"	100/100	----
611224	224	12-1/2"	14-1/2"	100/100	----
611248	248	10-3/4"	16"	100/100	----
611270	270	15-3/8"	17-3/8"	100/100	----
611312	312	18"	20"	100/100	----
611332	332	19-1/8"	21-1/4"	100/100	----
611390	390	22-7/8"	24-7/8"	100/100	----

350 & 620 WORM GEAR CLAMPS

TRUCK AND TRAILER

MINIATURE CLAMPS - 5/16" BAND**350 Series**

- 1/4" Hex Slotted 410 Stainless Steel Screw
- 5/16" Wide 301 Stainless Steel Band
- 301 stainless Steel Housing
- 6mm thick

All Stainless Steel
5/16" band, 1/4" screw

PART #	DIA. RANGE		BOX/CASE	
	MIN.	MAX.		
350004	7/32"	5/8"	200/2400	----
350005	7/16"	11/16"	200/2400	----
350006	5/16"	7/8"	200/2400	----
350008	7/16"	1"	200/1200	----
350010	1/2"	1-1/16"	200/1200	----
350012	9/16"	1-1/4"	200/1200	----
350016	11/16"	1-1/2"	200/1200	----
350020	7/8"	1-3/4"	200/1200	----

Applications: For agricultural, industrial and automotive uses. Corrosion resistance varies with stainless components.

Mechanically interlocked, 3 piece construction for service sealing pressure without spot welding.

1/2" WIDE BAND CLAMPS (12.70MM)**620 Series**

- 5/16" Hex Slotted 305 Stainless Steel Screw
- 1/2" Wide 301 Stainless Steel Band
- 301 Stainless Steel Housing
- 60mm Thickness
- Use for underground and other high corrosive applications.
- For a sure grip application.
- Especially suited to industrial applications

All Stainless Steel
1/2" band, 5/16" screw

PART #	#	DIA. RANGE		BOX/CASE	
		MIN.	MAX.		
620006	6	3/8"	7/8"	100/600	----
620008	8	7/16"	1"	100/600	----
620010	10	9/16"	1-1/16"	100/600	----
620012	12	9/16"	1-1/4"	100/600	----
620016	16	11/16"	1-1/2"	100/600	----
620020	20	3/4"	1-3/4"	100/300	----
620024	24	1-1/16"	2"	100/300	----
620028	28	1-5/16"	2-1/4"	100/300	----
620032	32	1-9/16"	2-1/2"	100/300	----
620036	36	1-13/16"	2-3/4"	50/200	----
620040	40	2-1/16"	3"	50/200	----
620044	44	2-5/16"	3-1/4"	50/200	----
620048	48	2-9/16"	3-1/2"	50/200	----
620052	52	2-13/16"	3-3/4"	25/100	----
620056	56	3-1/16"	4"	25/100	----
620060	60	3-5/16"	4-1/4"	25/100	----
620064	64	2-1/2"	4-1/2"	25/100	----
620072	72	3"	5"	25/100	----
620080	80	3-1/2"	5-1/2"	10/100	----
620088	88	4"	6"	10/100	----
620096	96	4-1/2"	6-1/2"	10/100	----
620104	104	5"	7"	10/100	----
620116	116	5-3/4"	7-3/4"	100/100	----
620128	128	6-1/2"	8-1/2"	100/100	----
620152	152	2"	10"	100/100	----
620164	164	1-3/4"	10-3/4"	100/100	----
620176	176	9-1/4"	11-1/4"	100/100	----
620188	188	9.9"	12-1/4"	100/100	----
620200	200	11"	13"	100/100	----
620212	212	11-3/4"	13-3/4"	100/100	----
620224	224	12-1/2"	14-1/2"	100/100	----
620248	248	10-3/4"	16"	100/100	----
620270	270	15-3/8"	17-3/8"	100/100	----
620312	312	18"	20"	100/100	----
620332	332	19-1/8"	21-1/4"	100/100	----
620390	390	22-7/8"	24-7/8"	100/100	----

WARNING: This product can expose you to chemicals, including lead, which are known to the State of California to cause cancer and birth defects or other reproductive harm. For more information, visit www.P65Warnings.ca.gov



#316 MARINE WORM GEAR CLAMPS

TRUCK AND TRAILER

MINIATURE CLAMPS - 5/16" BAND

All #316 SS for Marine Environments

5/16" band, 1/4" screw



PART #	DIA. RANGE		BOX/CASE	
	MIN.	MAX.		
350004SS	7/32"	5/8"	200/2400	----
350005SS	7/16"	11/16"	200/2400	----
350006SS	5/16"	7/8"	200/2400	----
350008SS	7/16"	1"	200/1200	----
350010SS	1/2"	1-1/16"	200/1200	----
350012SS	9/16"	1-1/4"	200/1200	----
350016SS	11/16"	1-1/2"	200/1200	----
350020SS	7/8"	1-3/4"	200/1200	----

350SS Series

- 1/4" Hex Slotted 316 Stainless Steel Screw
- 316 Stainless Steel Band
- 8mm wide
- 60 mm thick
- 316 stainless Steel Housing

Applications: For marine, agricultural, industrial and automotive uses. Corrosion resistance varies with stainless components.

Mechanically interlocked, 3 piece construction for service sealing pressure without spot welding.

1/2" WIDE BAND CLAMPS (12.70MM)



All #316 SS for Marine Environments

1/2" band, 5/16" screw

ALL 316SS PART #	#	DIA. RANGE		BOX/CASE	
		MIN.	MAX.		
620006SS	6	3/8"	7/8"	100/600	----
620008SS	8	7/16"	1"	100/600	----
620010SS	10	9/16"	1-1/16"	100/600	----
620012SS	12	9/16"	1-1/4"	100/600	----
620016SS	16	11/16"	1-1/2"	100/600	----
620020SS	20	3/4"	1-3/4"	100/300	----
620024SS	24	1-1/16"	2"	100/300	----
620028SS	28	1-5/16"	2-1/4"	100/300	----
620032SS	32	1-9/16"	2-1/2"	100/300	----
620036SS	36	1-13/16"	2-3/4"	50/200	----
620040SS	40	2-1/16"	3"	50/200	----
620044SS	44	2-5/16"	3-1/4"	50/200	----
620048SS	48	2-9/16"	3-1/2"	50/200	----
620052SS	52	2-13/16"	3-3/4"	25/100	----
620056SS	56	3-1/16"	4"	25/100	----
620060SS	60	3-5/16"	4-1/4"	25/100	----
620064SS	64	2-1/2"	4-1/2"	25/100	----
620072SS	72	3"	5"	25/100	----

620SS Series

- 5/16" Hex Slotted 316 Stainless Steel Screw
- 1/2" Wide 316 Stainless Steel Band
- 316 Stainless Steel Housing
- 60mm Thickness
- Use for marine, underground and other high corrosive applications.

WARNING: This product can expose you to chemicals, including lead, which are known to the State of California to cause cancer and birth defects or other reproductive harm. For more information, visit www.P65Warnings.ca.gov

SPRING LOADED T-BOLT

TRUCK AND TRAILER

SPRING LOADED T-BOLT HOSE CLAMP

- Per SAE standard J1508 Type "SLTB"
- .025 Band Thickness
- 3/4 (19mm) band width
- Heavy duty springs
- Band Material: 300 stainless
- T-bolt: Carbon steel w/ zinc plating
- Housing (Bridge): 300 Stainless
- Hex nut: Carbon Steel, Nylon insert
- Torque rating: 150 in-lbs (8.5 mm)



Purpose: To provide constant tension performance to compensate for the expansion and contraction when temperatures fluctuate. Provides high strength and a 360° seal. Tighten with a 7/16" wrench or hex nutdriver.

Services: Designed for use in high vibration and large diameter applications common in heavy trucks, industrial machinery, off road equipment, agricultural irrigation and machinery, for air intake and coolant adapter

PART #	SAE #	MIN - MAX	WGT	BOX QTY	
844213	40	2.13 - 2.44	0.170	100	----
844225	44	2.25 - 2.56	0.174	100	----
844238	48	2.38 - 2.69	0.179	100	----
844250	52	2.50 - 2.81	0.181	100	----
844263	56	2.63 - 2.94	0.183	100	----
844275	60	2.75 - 3.06	0.185	100	----
844300	68	3 - 3.31	0.187	100	----
844306	70	3.06 - 3.38	0.190	100	----
844313	72	3.13 - 3.44	0.192	100	----
844325	76	3.25 - 3.56	0.194	100	----
844338	80	3.38 - 3.69	0.196	100	----
844350	84	3.50 - 3.81	0.196	100	----
844356	86	3.56 - 3.88	0.196	100	----
844363	88	3.63 - 3.94	0.198	100	----
844375	92	3.75 - 4.06	0.198	100	----
844406	102	4.06 - 4.38	0.203	100	----
844413	104	4.13 - 4.44	0.209	100	----
844425	108	4.25 - 4.56	0.214	100	----
844456	118	4.56 - 4.88	0.216	100	----
844500	132	5 - 5.31	0.218	100	----
844525	140	5.25 - 5.56	0.220	100	----
844600	164	6 - 6.31	0.223	100	----
844625	172	6.25 - 6.56	0.225	100	----

Automatically adjust diameter for hose expansion and contraction due to temperature changes.

WARNING: This product can expose you to chemicals, including lead, which are known to the State of California to cause cancer and birth defects or other reproductive harm. For more information, visit www.P65Warnings.ca.gov



CONSTANT TORQUE/ V-BAND

TRUCK AND TRAILER

CONSTANT TORQUE HOSE CLAMPS

- All designs meet SAE J1508 specifications type "SLHD"
- .028 Band thickness
- Band material: 304 thickness
- Band width: 9/16" for 45in-lb
5/8" for 90in-lb
- Band material: 304 stainless
- Housing: 304 stainless steel
- Bridge: 410 stainless steel
- Hex screw: 410 stainless steel



Purpose: To eliminate leaks by automatically increasing or decreasing the clamps diameter, decreasing the need for retightening. Constant torque clamps have an extended tail on the band to protect soft hose or tube from being cut.

Services: Constant torque clamps are an excellent choice for fluctuating and extreme temperature applications and thermal compensation.

PART #	CLAMPING RANGE	BAND WIDTH	TORQUE	SCREW SIZE	WGT	BOX QTY	
842010	9/16" - 1 1/16"	9/16"	72 in-lb	5/16"	0.106	100	----
842012	11/16" - 1 1/4"	9/16"	72 in-lb	5/16"	0.108	100	----
842016	13/16" - 1 1/2"	9/16"	72 in-lb	5/16"	0.112	100	----
842020	13/16" - 1 3/4"	9/16"	72 in-lb	5/16"	0.119	100	----
842024	1 1/16" - 2"	9/16"	72 in-lb	5/16"	0.121	100	----
842200	1 1/4" - 2 1/8"	5/8"	130 in-lb High	3/8"	0.207	100	----
842250	1 3/4" - 2 5/8"	5/8"	130 in-lb High	3/8"	0.216	100	----
842300	2 1/4" - 3 1/8"	5/8"	130 in-lb High	3/8"	0.220	100	----
842350	2 3/4" - 3 5/8"	5/8"	130 in-lb High	3/8"	0.225	100	----
842400	3 1/4" - 4 1/8"	5/8"	130 in-lb High	3/8"	0.231	100	----
842450	3 3/4" - 4 5/8"	5/8"	130 in-lb High	3/8"	0.238	100	----
842500	4 1/4" - 5 1/8"	5/8"	130 in-lb High	3/8"	0.256	100	----

V-BAND HOSE CLAMPS

- Band thickness: see chart
- Band width: see chart
- Band material: 300 stainless
- Trunnion: 300 stainless
- 1/4" T-bolt: 300 stainless

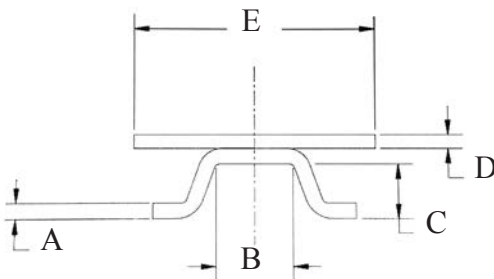

Purpose: to provide a fast, secure coupling for connecting flanged joints.

Services: V-Band clamps feature high strength and positive sealing integrity for applications including: heavy duty diesel engine exhaust and turbochargers, filter housings, emissions and general industrial applications.

PART#	NOMINAL DIAMETER	V-INSERT SECTIONS			BANDS		WGT	BOX QTY	
		A	B	C	D	E			
843321	3.21	0.050	0.262	0.141	0.035	0.750	0.525	100	----
843382	3.82	0.077	0.207	0.281	0.040	0.875	0.531	100	----
843388	3.88	0.050	0.400	0.281	0.040	0.875	0.536	100	----
843450	4.50	0.077	0.207	0.281	0.040	0.875	0.547	100	----
843461	4.61	0.050	0.156	0.281	0.035	0.750	0.549	100	----
843475	4.75	0.050	0.400	0.281	0.040	0.875	0.553	100	----
843525	5.25	0.050	0.262	0.141	0.035	0.750	0.567	100	----
843588	5.88	0.050	0.400	0.281	0.040	0.875	0.575	100	----

WARNING: This product can expose you to chemicals, including lead, which are known to the State of California to cause cancer and birth defects or other reproductive harm. For more information, visit www.P65Warnings.ca.gov

TRUCK & TRAILER

MUFFLER

TRUCK AND TRAILER

MUFFLER CLAMPS

Muffler Clamps are designed with elongated and tapered holes that pulls the legs around the pipe as the nuts tighten, making a tight seal. Other clamp legs do not wrap around the pipe, they stay straight and the clamp only connects at two points.

- Carbon steel band, housing and bridge
- All muffler clamps are zinc plated for superior corrosion resistance
- Heavy duty U-Bolt and band construction
- 3/8 U-bolt
- Base 2.4mm

SADDLE

PART #	SIZE	WGT	BOX QTY	
841175	1-3/4"	0.335	50	----
841200	2"	0.410	50	----
841250	2-1/2"	0.448	50	----
841300	3"	0.582	50	----
841350	3-1/2"	0.741	50	----
841400	4"	0.847	25	----
841450	4-1/2"	1.023	25	----
841500	5"	1.067	25	----

FLAT BAND

PART #	SIZE	WGT	BOX QTY	
841004	4"	0.847	25	----
841005	5"	1.093	25	----

GUILLOTINE - PROVIDES A COMPLETE 360° HEAVY DUTY SEAL

PART #	SIZE	WGT	BOX QTY	
841040	4"	0.820	25	----
841045	4-1/2"	0.847	25	----
841050	5"	0.988	25	----

WARNING: This product can expose you to chemicals, including lead, which are known to the State of California to cause cancer and birth defects or other reproductive harm. For more information, visit www.P65Warnings.ca.gov



EXHAUST CLAMPS

Complete with:

- One metal band - 76mm width
- One spacer
- Two bolts
- Two reaction blocks
- Individually boxed

- Pre-attached hardware for easy and accurate installation.

- Conforms to pipe and flex tubing to create the best seal available without distorting any pipes.

ALUMINIZED STEEL BUTT CLAMPS

- .7mm band thickness
- 76mm band width



PART #	SIZE	WGT	BOX QTY	
845200	2"	0.970	50	----
845300	3"	1.058	50	----
845350	3.50"	1.102	50	----
845400	4"	1.146	50	----
845500	5"	1.235	50	----
845600	6"	1.323	50	----
845-500SS*	5"	1.190	50	----

*Light pattern .5mm band thickness

ALUMINIZED STEEL LAP CLAMPS

- .7mm band thickness
- 76mm band width



PART #	SIZE	WGT	BOX QTY	
846200	2"	0.970	50	----
846250	2.50"	1.014	50	----
846275	2.75"	1.036	50	----
846300	3"	1.058	50	----
846350	3.50"	1.102	50	----
846400	4"	1.146	50	----
846500	5"	1.235	50	----

STAINLESS STEEL LAP CLAMPS

- .5mm band thickness
- 76mm band width



PART #	SIZE	WGT	BOX QTY	
847200	2"	0.926	50	----
847250	2.50"	0.970	50	----
847275	2.75"	0.992	50	----
847300	3"	1.014	50	----
847350	3.50"	1.058	50	----
847400	4"	1.102	50	----
847500	5"	1.190	50	----
847600	6"	1.279	50	----

STAINLESS STEEL EASY-FORM CLAMPS

- .5mm band thickness
- 76mm band width



PART #	SIZE	WGT	BOX QTY	
848200	2"	0.926	50	----
848225	2.25"	0.948	50	----
848250	2.50"	0.970	50	----
848275	2.75"	0.992	50	----
848300	3"	1.014	50	----
848350	3.50"	1.058	50	----
848400	4"	1.102	50	----
848500	5"	1.190	50	----
848600	6"	1.279	50	----
848700	7"	1.367	50	----

WARNING: This product can expose you to chemicals, including lead, which are known to the State of California to cause cancer and birth defects or other reproductive harm. For more information, visit www.P65Warnings.ca.gov

AUTO TRUCK AND MARINE HOSE

TRUCK AND TRAILER

SILICONE COOLANT HOSE



APPLICATION: Truck and bus fleets and other areas where long service life under high temperature conditions is required.

COVER: Blue heat and weather resistant silicone with wrapped impression finish.

REINFORCEMENT: Multiple plies of polyester fabric.

TUBE: Red heat resistant silicone.

TEMPERATURE: -54C to +177C (-65F to +350F)

Item No	Nom. ID"	Nom. OD"	PSI	Std Pack	Weight#
SILC-038	3/8	0.75	110	12'	0.20
SILC-050	1/2	0.88	110	12'	0.25
SILC-063	5/8	1.00	110	12'	0.30
SILC-075	3/4	1.13	110	12'	0.33
SILC-088	7/8	1.26	110	12'	0.40
SILC-100	1	1.38	90	12'	0.43
SILC-106	1-1/16	1.44	90	12'	0.45
SILC-113	1-1/8	1.51	90	12'	0.47
SILC-125	1-1/4	1.63	85	12'	0.53
SILC-131	1-5/16	1.69	85	12'	0.55
SILC-138	1-3/8	1.76	85	12'	0.58
SILC-150	1-1/2	1.88	80	12'	0.60
SILC-163	1-5/8	2.00	80	12'	0.60
SILC-175	1-3/4	2.13	80	12'	0.68
SILC-187	1-7/8	2.26	80	12'	0.68
SILC-200	2	2.38	75	12'	0.78
SILC-213	2-1/8	2.50	75	12'	0.87
SILC-225	2-1/4	2.63	65	12'	0.87
SILC-238	2-3/8	2.76	65	12'	0.90
SILC-250	2-1/2	2.88	65	12'	0.93
SILC-263	2-5/8	3.00	60	12'	1.00
SILC-275	2-3/4	3.13	50	12'	1.03
SILC-300	3	3.38	50	12'	1.13
SILC-350	3-1/2	3.88	35	12'	1.37
SILC-400	4	4.38	35	12'	1.53
SILC-450	4-1/2	4.88	25	12'	1.68
SILC-500	5	5.38	25	12'	1.88
SILC-550	5-1/2	5.88	20	12'	2.13
SILC-600	6	6.38	20	12'	2.20

Cut Lengths: No Cut Lengths

Standard Length: 4'/12'

SILICONE TURBO HUMP HOSE

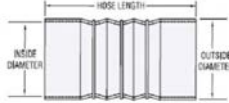

APPLICATION: Truck and bus fleets and other areas where long service life under high temperature conditions is required. Designed and engineered to provide a connection between engine mounted charge air systems components. Ideal for slight misalignments and isolating vibration between hose ends.

COVER: Blue (Cold Side) and Red (Hot Side -H) heat and weather resistant silicone. 316 stainless steel restraining rings reduce swell and increased hoop strength.

REINFORCEMENT: 4 ply polyester fabric for Cold Side application. 4 ply silicone aramid reinforced for Hot Side application (-H)

TUBE: Blue (Cold Side) and Red (Hot Side) heat resistant silicone.

TEMPERATURE: -54C to +177C (-65F to +350F) for Cold Side : -54C to +260C (-65F to +500F) for Hot Side (-H)

Item No	Nom. ID"	Nom. OD"	Std Pack
SILT-300	3	3.26	6.00"
SILT-350-H	3-1/2	3.72	6.00"
SILT-400	4	4.26	6.00"
SILT-400-H	4	4.22	6.00"
SILT-500-H	5	5.22	6.00"

WARNING: This product can expose you to chemicals, including lead, which are known to the State of California to cause cancer and birth defects or other reproductive harm. For more information, visit www.P65Warnings.ca.gov



SILICONE HOSE

TRUCK AND TRAILER

SILICONE HEATER HOSE



APPLICATION: Truck and bus fleets and other areas where long service life under high temperature conditions is required.

COVER: Blue heat and weather resistant silicone.

REINFORCEMENT: Multiple plies of polyester fabric.

TUBE: Red heat resistant silicone.

TEMPERATURE: -54C to +177C (-65F to +350F)

Item No	Nom. ID"	Nom. OD"	PSI	Std Pack	Weight#
SILH-025	1/4	0.50	75	250'	0.08
SILH-031	5/16	0.58	65	250'	0.06
SILH-038	3/8	0.66	65	250'	0.10
SILH-050	1/2	0.80	65	250'	0.15
SILH-063	5/8	0.97	65	250'	0.25
SILH-075	3/4	1.13	50	250'	0.30
SILH-100	1	1.42	45	100'	0.45

Cut Lengths: Plus 5%

Standard Length: 25'/50' or reels.

Recommended Couplings: Barbed short shank, combination nipples

WARNING: This product can expose you to chemicals, including lead, which are known to the State of California to cause cancer and birth defects or other reproductive harm. For more information, visit www.P65Warnings.ca.gov

TRUCK & TRAILER